

DEPARTMENT OF THE ARMY TECHNICAL MANUAL

OPERATOR'S MANUAL

RADIO SET
AN/GRC-26D

This copy is a reprint which includes current pages from Changes 1 through 4.

HEADQUARTERS, DEPARTMENT OF THE ARMY
JUNE 1969

WARNING

DANGEROUS VOLTAGES EXIST IN THIS EQUIPMENT

Be careful when working on the power supply circuits, on the 115-volt ac line connections, or on the 240-volt plate circuits in Receiver, Radio R-390 (*)/URR. Observe safety precautions when working on the transmitting antenna or the transmitting antenna terminals because high radio-frequency voltages exist at these points.

DON'T TAKE CHANCES!

EXTREMELY DANGEROUS VOLTAGES EXIST IN THE FOLLOWING UNITS:

Transmitter, Radio T-368 (*)/URT	2,400-volt circuits
Converter, Frequency Shift CV-116 (*)/URR	620-volt circuits

WARNING VENTILATION

The shelter must be ventilated when occupied. Be sure the vents, window shutters, or door is open when the equipment is operated. Keep the shelter air intake fan closed during the transportation. The truck exhaust stack is near the air intake vent, and there is danger of carbon monoxide poisoning. When the vehicle is moving, adequate air circulation exists through the shelter windows.

WARNING ANTENNAS

Operator and maintenance personnel should be familiar with the requirements of TB SIG 291 before attempting installation or operation of the equipment covered in this manual. Failure to follow requirements of TB SIG 291 could result in injury or DEATH.

**WARNING
RADIATION HAZARD**

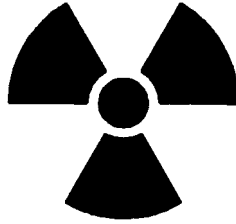

**RADIOACTIVE MATERIAL
CONTROLLED DISPOSAL REQUIRED
ACCOUNTABILITY NOT REQUIRED
STD RW--2**

Audio level meter.....	Ra 226.....	0.69uCi.....	6625-00-669-0769
Audio level meter.....	Ra 226.....	0.40uCi.....	6625-00-669-0770
Electron Tube CC3W			5960-00-1880968
Sylvania.....	Co 60.....	1.0uCi	
Electron Tube OA2WA			5960-00-503-4880
EEVC.....	U 238.....	0.1uCi	
CBS Hytron.....	Ni 63.....	0.5uCi	
Raytheon.....	Co 60.....	0.2uCi	
Electron Tube OA2WA			
EEVC.....	U 238.....	0.1uCi	
CBS Hytron.....	Ni 62.....	0.5uCi	
Raytheon.....	Co 60.....	0.2uCi	

Radiation Hazard Information: The following radiation hazard information must be read and understood by all personnel before operating or repairing Radio Set AN/GRC-26D. Hazardous radioactive materials are present in the above listed components of the MD-239A/GR, R-290/URR, C-632/GRC-10, R-125/GRC10, and T-235/GRC10.

The components are potentially hazardous when broken. See qualified medical personnel and the local Radiological Protection Officer (RPO) immediately, if you are exposed to or cut by broken components. First aid instructions are contained in TB 43-0116, TB 43-0122, and AR 75515.

NEVER place radioactive components in your pocket.

Use extreme care NOT to break radioactive components while handling them.

NEVER remove radioactive components from cartons until you are ready to use them.

Change 3

If any of these components are broken, notify the local RPO immediately. The RPO will survey the immediate area for radiological contamination and will supervise the removal of broken components.

The above listed radioactive components will not be repaired or disassembled.

Disposal of broken, unserviceable, or unwanted radioactive components will be accomplished in accordance with the instructions in AR 755-15.



5

SAFETY STEPS TO FOLLOW IF SOMEONE IS THE VICTIM OF ELECTRICAL SHOCK

1

DO NOT TRY TO PULL OR GRAB THE INDIVIDUAL

2

IF POSSIBLE, TURN OFF THE ELECTRICAL POWER

3

IF YOU CANNOT TURN OFF THE ELECTRICAL POWER, PULL, PUSH OR LIFT THE PERSON TO SAFETY USING A DRY WOODEN POLE OR A DRY ROPE OR SOME OTHER INSULATING MATERIAL

4

SEND FOR HELP AS SOON AS POSSIBLE

5

AFTER THE INJURED PERSON IS FREE OF CONTACT WITH THE SOURCE OF ELECTRICAL SHOCK, MOVE THE PERSON A SHORT DISTANCE AWAY AND IMMEDIATELY START ARTIFICIAL RESUSCITATION

FIXED OPERATION WITH LONG RANGE ANTENNAS

WARNING

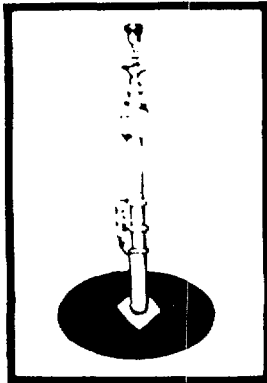
TELESCOPING
ANTENNA MAST

TYPICAL TOWER

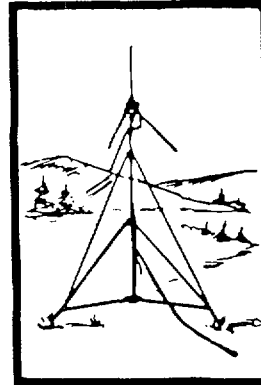
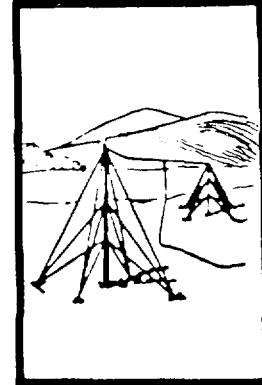
EXTENDED RANGE
ANTENNA

DOUBLET ANTENNA

NEVER ERECT THESE LONG RANGE ANTENNAS DIRECTLY UNDER POWERLINES.

IF YOU MUST ERECT THESE LONG RANGE ANTENNAS NEAR POWERLINES, POWERLINE POLES OR TOWERS, OR BUILDINGS WITH OVERHEAD POWERLINE CONNECTIONS, NEVER PUT THE ANTENNA CLOSER THAN TWO TIMES THE ANTENNA HEIGHT FROM THE BASE OF THE POWERLINE, POLE, TOWER OR BUILDINGS.

NEVER ATTEMPT TO ERECT ANY LONG RANGE ANTENNA WITHOUT A FULL TEAM.

BEFORE ERECTING ANY LONG RANGE ANTENNA, INSPECT ALL THE PARTS MAKING UP THE ANTENNA KIT. DO NOT ERECT THE ANTENNA IF ANY PARTS ARE MISSING OR DAMAGED.

DO AS MUCH OF THE ASSEMBLY WORK AS POSSIBLE ON THE GROUND.

WHEN ERECTING THE ANTENNA, ALLOW ONLY TEAM PERSONNEL IN THE ERECTION AREA,

MAKE SURE THAT THE AREA FOR THE ANCHORS IS FIRM. IF THE GROUND IS MARSHY OR SANDY, GET SPECIFIC INSTRUCTIONS FROM YOUR CREW CHIEF OR SUPERVISOR ON HOW TO REINFORCE THE ANCHORS,

WHEN SELECTING LOCATIONS FOR ANCHORS, AVOID TRAVELED AREAS AND ROADS. IF YOU CANNOT AVOID THESE AREAS, GET SPECIFIC INSTRUCTIONS FROM YOUR SUPERVISOR AS TO WHAT CLEARANCE YOUR GUY WIRES AND ROPES MUST HAVE OVER THE TRAVELED AREAS AND ROAD.

CLEARLY MARK ALL GUY WIRES AND ROPES WITH THE WARNING FLAGS OR SIGNS SUPPLIED BY YOU UNIT. IN AN EMERGENCY, USE STRIPS OF WHITE CLOTH AS WARNING STREAMERS.

IF YOU SUSPECT THAT POWERLINES HAVE MADE ACCIDENTAL CONTACT WITH YOUR ANTENNA, STOP OPERATING, ROPE OFF THE ANTENNA AREA, AND NOTIFY YOUR SUPERIORS.

IF THE WEATHER IN YOUR AREA CAN CAUSE ICE TO FORM ON YOUR LONG RANGE ANTENNA AND ITS GUY WIRES AND ROPES, ADD EXTRA GUYS TO SUPPORT THE SYSTEM. ROPE OFF THE AREA AND POST IT WITH WARNING SIGNS LIKE BEWARE OF FALLING ICE.

DO NOT TRY TO ERECT ANY ANTENNA DURING AN ELECTRICAL STORM.

KEEP A SHARP EYE ON YOUR ANCHORS AND GUYS. CHECK THEM DAILY AND IMMEDIATELY BEFORE AND AFTER BAD WEATHER.

WARNING

SERIOUS INJURY OR EVEN DEATH CAN HAPPEN IF THE FOLLOWING ARE NOT CAREFULLY OBSERVED WHEN INSTALLING AND USING THE ANTENNAS USED WITH YOUR RADIO SETS,

**BEFORE ANY
MISSION FIND
OUT**

1. ARE THERE ANY POWERLINES IN YOUR AREA OF OPERATION ?
2. HIGH ARE THESE POWERLINES ?
3. HOW TALL ARE THE POLES OR TOWERS CARRYING POWERLINES ?

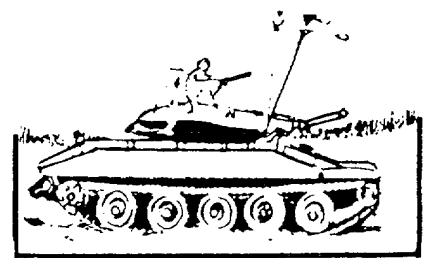
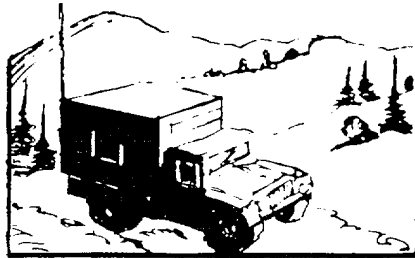
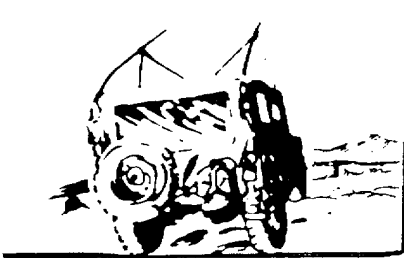
MOBILE OPERATION WITH WHIP ANTENNAS**DO NOT STOP YOUR VEHICLE UNDER POWERLINES.**

- IF POSSIBLE, TRY TO MAINTAIN MOBILE COMMUNICATIONS WITH YOUR ANTENNA(S) TIED DOWN,
- MAKE SURE AN ANTENNA TIP CAP IS SECURELY TAPED ON THE END OF EACH WHIP ANTENNA.
- DO NOT LEAN AGAINST OR TOUCH A WHIP ANTENNA WHILE THE TRANSMITTER IS ON,
- DURING CROSS-COUNTRY OPERATION, DO NOT ALLOW ANYONE TO STICK AN ARM, LEG OR WEAPON OVER THE SIDES OF THE VEHICLE, IF YOUR ANTENNA ACCIDENTALLY TOUCHES A POWERLINE AND A LEG, ARM OR WEAPON CONTACTS A DAMP BUSH OR THE GROUND, A SERIOUS OR FATAL ACCIDENT CAN HAPPEN.
- IF YOU ARE NOT SURE THAT AN ANTENNA ON YOUR VEHICLE WILL CLEAR A POWERLINE, STOP BEFORE YOU GET CLOSE TO THE POWERLINE AND EITHER CAREFULLY TIE DOWN THE ANTENNA OR REMOVE ANTENNA SECTIONS TO MAKE SURE THAT YOU CAN SAFELY DRIVE UNDER THE POWERLINE.

Technical Manual }
 No. 11-5820-256-10 }

HEADQUARTERS
 DEPARTMENT OF THE ARMY
 Washington, D. C., 19 June 1969

**Operator's Manual
 RADIO SET AN/GRC-26D**

		Paragraph	Page
Chapter	1. INTRODUCTION	1-1-1-30	1-1
	2. INSTALLATION	2-1-2-10	2-1
	3. OPERATING INSTRUCTIONS		
Section	I. Operator's controls and indicators	3-1-3-4	3-1
	II. Operation	3-5-3-16	3-7
Chapter	4. MAINTENANCE INSTRUCTIONS	4-1-4-9	4-1
	5. SHIPMENT AND LIMITED STORAGE AND DEMOLITION TO PREVENT ENEMY USE		
Section	I. Shipment and limited storage	5-1,5-2	5-1
	II. Demolition of materiel to prevent enemy use	5-3,5-4	5-1
Appendix	A. REFERENCES		A-1
	B. BASIC ISSUE ITEMS LIST (BIIL) AND ITEMS TROOP INSTALLED OR AUTHORIZED LIST (ITIAL)		B-1
Section	I. Introduction		B-1
	II. Basic issue items list		
	III. Items troop installed or authorized list		
Index		I-1

*This manual supersedes TM 11-5820-256-10, 20 July 1961, Including all changes.

Change 1 i

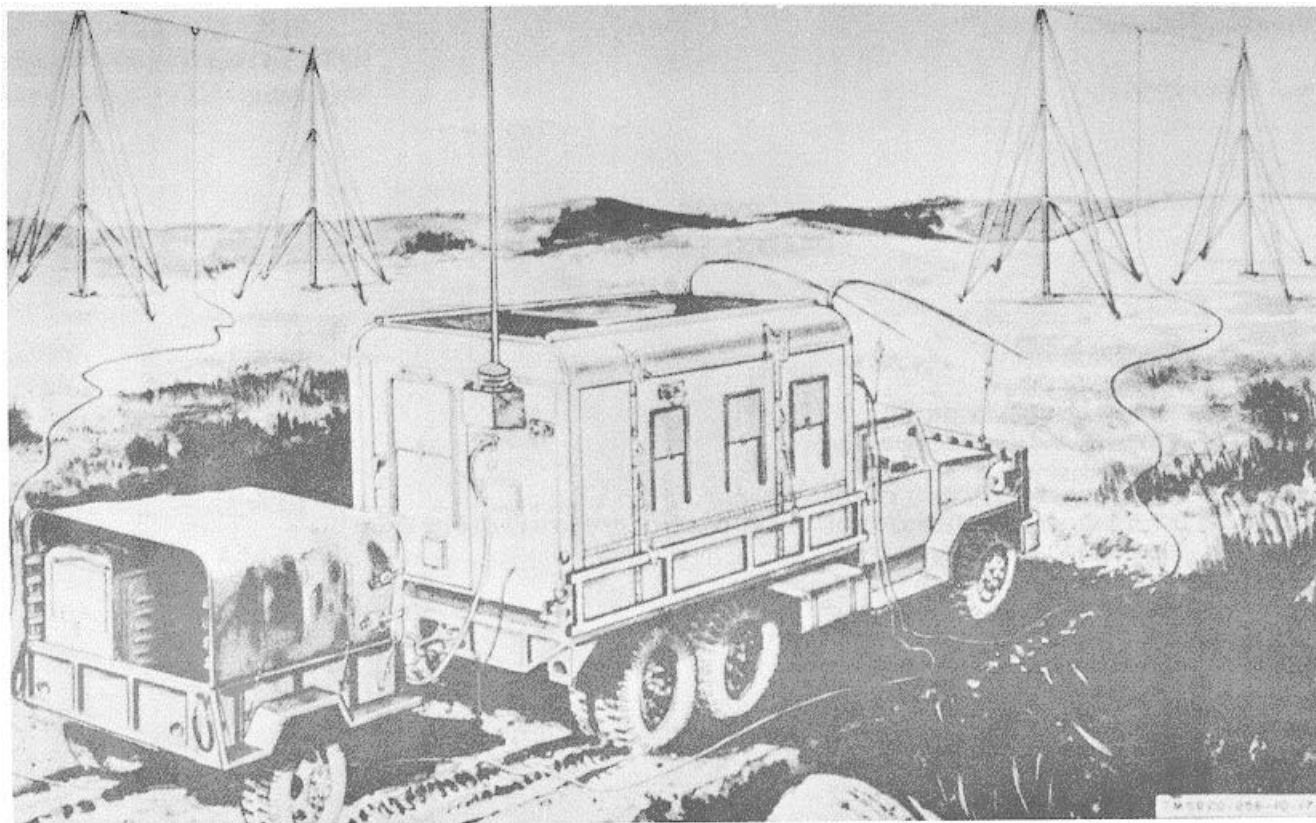
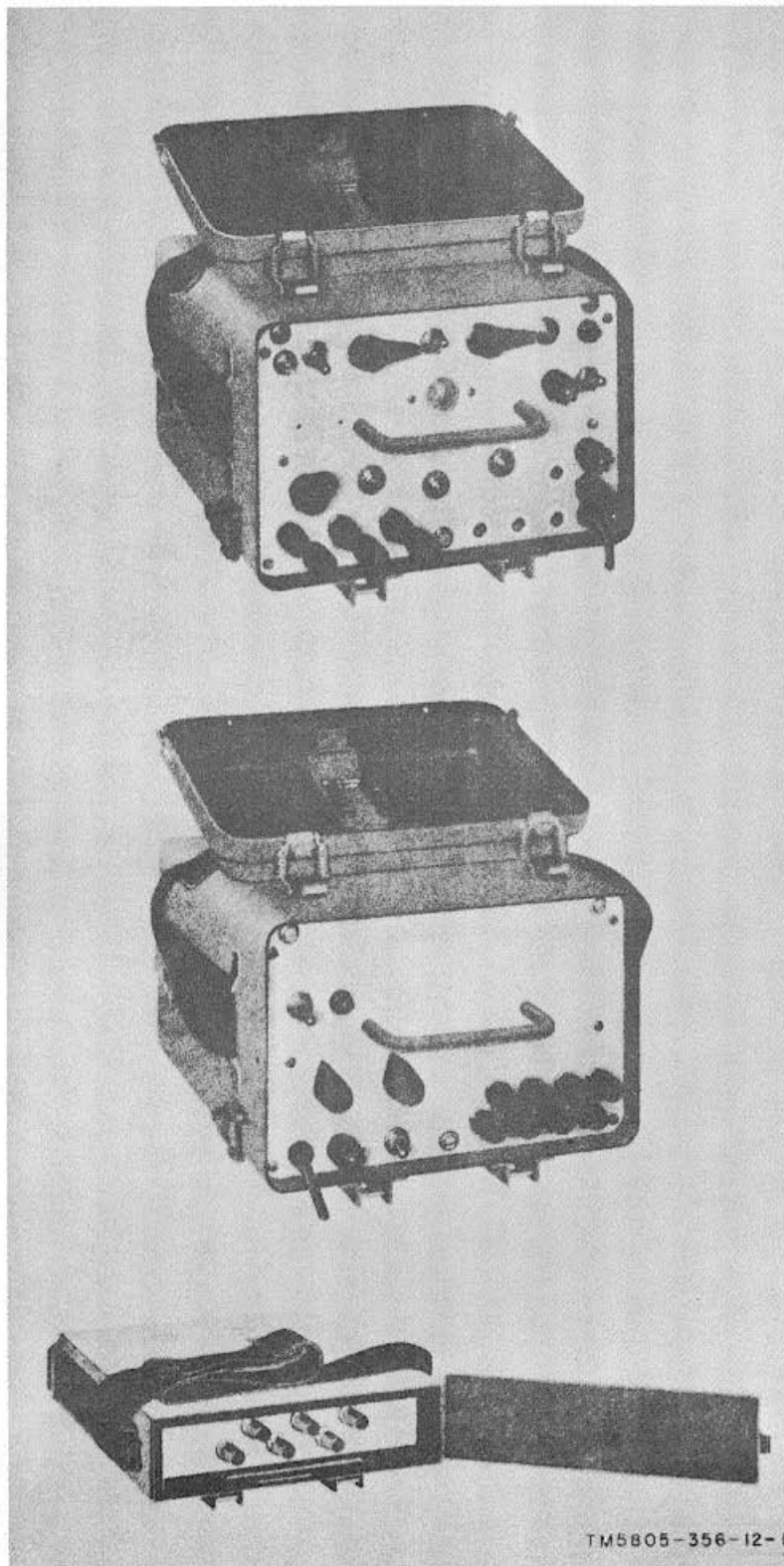

Figure 1-1. Radio Set AN/GRC-26D, mounted on truck.



TM5805-356-12-1

Figure 1-1. Terminal, Telegraph-Telephone AN/TCC-29

**CHAPTER 1
INTRODUCTION**

1-1. Scope

a. This manual describes Radio Set AN/GRC-26D (fig. 1-1) and covers its installation, operation, and operator's maintenance. It includes operation under usual conditions, as well as operation with security equipment; cleaning and inspection of equipment; and replacement of the parts available to the operator. Detailed discussion of Modulator, Radio MD239(*)/GR; Switch Box SA-331/U; Control, Radio Set C-1123/GRC; and Control, Remote Switching C1474/GRC is provided. Detailed information pertaining to the remainder of the major components comprising Radio Set AN/GRC-26D is contained in the technical manuals listed in appendix A.

b. Official nomenclature followed by (*) is used to indicate all models of the equipment. The chart below is a list of such equipments discussed in this manual.

Nomenclature	Models represented
Receiver, Radio R-390(*)/URR.	R-390/URR, R-390A/URR
Mast Bracket MP-50--(*)	MP-50, MP-50-A
Converter, Frequency Shift CV-116(*)/URR	CV-116/URR, CV-116A/URR, CV-116B/URR, CV-116C/URR.
Loudspeaker Assembly LS-206(*)/U.	LS-206/U, LS-206A/U
Reperforator-Transmitter, Teletypewriter TT-76 (*)/GGC.	TT-76/GGC, TT-76A/GGC, TT-76B/GGC.
Teletypewriter TTf-98 (*)/FG	TT-98/FG, TI98A/FG, TT-98B/FG.
Cabinet, Storage CY-1721 (*)/GRC.	CY-1721/GRC, CY-1721A/GRC
Mast AB-155(')/U	AB-155/U, AB155A/U, AB-155B/U.
Modulator, Radio MD 239(*)/GR.	MD-239 GR, MD-239A/GR
Transmitter, Radio T-368 (*)/URT.	T-368/URT, T-368A/URT, T-368B/URT, T-368C/URT, T-368D/URT, T-368E/URT, T-368F/URT.
Microphone M-29(*)/U.....	M-29/U, M-29A/U
Shelter, Electrical Equipment S-56(*)/G.	S-56A/G, S-56B/G
Mast Section MS-44-(*).....	MS-44, MS44:A
Guy MX-381(')/GRA4	MX-381/GRA-4, MX-381A/GRA-4.
Guy MX-382(*)/GRA-4	MX-382/GRA-4, MX-382A/GRA-4.
Guy MX-383(*)/GRA-4	MX-383/GRA-4, MX-516A/GRA-4.
Halyard MX-516(*)/GRA-4	MX-515/GRA-4, MX-516A/GRA-4.

1-2. Indexes of Publications

a. *DA Pam 310-4.* Refer to the latest issue of DA Pam 310-4 to determine whether there are new editions, changes, or additional publications pertaining to this equipment.

b. *DA Pam 310-7.* Refer to DA Pam 310-7 to determine whether there are modification work orders (MWO's) pertaining to the equipment.

1-3. Forms and Records

a. *Reports of Maintenance and Unsatisfactory Equipment.* Maintenance forms, records, and reports which are to be used by maintenance personnel at all maintenance levels are listed in and prescribed by TM 38-750.

b. *Report of Packaging and Handling Deficiencies.* Fill out and forward DD Form 6 (Packaging Improvement Report) as prescribed in AR 70058/NAVSUPINST 4030.29/AFR 71-13/MCO P4030.29A, and DLAR 4145.8.

c. *Discrepancy in Shipment Report (DISREP) (SF 361).* Fill out and forward Discrepancy in Shipment Report (DISREP) (SF 361) as prescribed in AR 55-38/NAVSUPINST 4610.53B/AFR 75-18/MCO P4610.19C, DLAR 4500.15.

1-3.1. Reporting of Errors

The reporting of errors, omissions, and recommendations for improving this publication by the individual user is encouraged. Reports should be submitted on DA Form 2028 (Recommended Changes to Publications and Blank Forms) and forwarded direct to Commander, US Army Communications and Electronics Materiel Readiness Command, ATTN: DRSEL-ME-MQ, Fort Monmouth, NJ 07703.

1-3.2. Administrative Storage

Administrative storage of equipment issued to and used by Army activities shall be in accordance with TM 740-90-1.

1-3.3. Destruction of Army Electronics Materiel

Destruction of Army electronics materiel to prevent enemy use shall be in accordance with TM 750-244-2.

1-3.4. Reporting Equipment Improvement Recommendations (EIR)

EIR's will be prepared using Standard Form 368 (Quality Deficiency Report). Instructions for preparing EIR's are provided in TM 38-750, the Army Maintenance Management System. EIR's should be

mailed direct to Commander, US Army Communications and Electronics Materiel Readiness Command, ATTN: DRSEL-ME-MQ, Fort Monmouth, NJ 07703. A reply will be furnished direct to you.

1-4. Purpose and Use

a. Purpose. Radio Set AN/GRC-26D (fig. 1-1) is a self-contained radio-teletypewriter station operating over a frequency range of 1.5 to 20.0 megahertz (MHz) with a power output of approximately 450 watts. The AN/GRC-26D provides facilities for transmission and reception of

frequency-shift keying (fsk), amplitude-modulated (am.) voice, continuous-wave (cw), and combination frequency-shift keying and amplitude-modulated (fsk-am.) signals. Facilities are also provided for operation with security equipment. Normally, am. voice or cw service is used only in an emergency or when operating conditions prevent the use of the fsk facilities. Voice communication may be superimposed upon an fsk signal without modifying.

1-5.1. Items Comprising Operable Radio Sets AN/GRC-26D (FSN 5815-518-0399), and AN/GRC-26D modified by MWO 11-5820-256-35/1

FSN.	QUANTITY		Nomenclature, part No., and mfr code
	AN GRC-26D	AN/GRC-26D with MWO	
			NOTE
			The part number is followed by the applicable 5-digit Federal supply code for manufacturers (FSCM) identified in SB 708-42 and used to identify manufacturer, distributor, or Government agency, etc.
			Modification Kit: For AN/GRC-26D
5815-082-3868		1	Axle, RL-27D
3895-356-3937	1		Blower Assembly, Electrical HD-223/G
4140-347-6807	1		Bracket MP-50-A
5820-404-2718	1		Bracket MT-657/GRC
5820-497-8596	1		Cabinet, Electrical, CY-1807/G
5820-503-0951	1		Cable Assembly, Power, Electrical: (5 ft 5 in) SC-C-7548A; 80063
5995-519-1146	1		Cable Assembly, Radio Frequency CG-409/G: (3 ft 0 in.)
5995-889-0751		1	Cable Assembly, Radio Frequency CG409G/U: (8 ft)
5995-823-2974	1		Cable Assembly, Radio Frequency CG-629A/U: (75 ft)
5995-752-1362	1		Cable Assembly, Radio Frequency CG-718A/U: (8 ft)
5995-752-2056	2		Cable Assembly, Radio Frequency CG-718A/U: (25 ft 6 in)
5995-636-3329	1		Cable Assembly, Special Purpose Electrical CX-1200: (3 ft 9 in)
5995-170-8780	2		Cable Assembly, Special Purpose, Electrical CX-1201/U: (5 ft 2 in)
	2		Cable Assembly, Radio Frequency CG-1 333/U: (4 ft)
5995-752-2335	1		Cable Assembly, Power Electrical CX-1 166/U: (50 ft)
5995-170-7929	2		Cable Assembly CG-1334/U: (500 ft)
5995-823-2012	2		Cable Assembly, Special Purpose, Electrical CX-1852/U: (6 ft)
5995-349-4844	1		Cable Assembly, Power Electrical CX-2254/U: (10 ft)
5995-903-7725	2		Cable Assembly, Special Purpose CX-3267/U: (12 ft 6 in.)
5995-752-2139	1		Cable Assembly, Special Purpose CX-3268/U: (14 ft)
5995-510-0615	2		Cable Assembly, Power Electrical CX-6485/U: (12 ft 6 in.)
5995-752-2511	1		Cable Assembly, Special Purpose, Electrical CX-9994A/U: (3 ft)
5995-926-0772		1	Cable Assembly, Special Purpose, Electrical CX-9995A/U: (3 ft 0 in.)
5995-926-0774		1	Cable Assembly, Special Purpose, Electrical CX-9995A/U: (8 ft 6 in.)
5885-926-0775		1	Cable Assembly, Special Purpose, Electrical CX-9996A/U: (10 ft)
5995-926-0773		1	Cable Assembly, Special Purpose, Electrical CS-9997A/U: (8 ft 6 in.)
5995-926-0831		1	Cable Assembly, Special Purpose, Electrical CX-9998/U: (8 ft 6 in.)
5995-926-0818		1	Cable Assembly, Special Purpose, Electrical CX-11411/U: (8 ft 6 in.)
5995-999-0116		1	Cable Assembly, Special Purpose, Electrical CX-11412: (18 ft 10 in.)
5995-926-0819		1	Cable Assembly, Special Purpose, Electrical CX-1 1413: (8 ft 6 in.)
5995-926-0807		1	Cable Assembly, Special Purpose, Electrical CX-1 1414/U: (8 ft 6 in.)
5995-926-0817		1	Cable Assembly, Special Purpose, Electrical CX-11415/U: (2 ft 6 in.)
5995-926-0836		1	Cable Assembly, Special Purpose, Electrical CX-11415/U: (6 ft 6 in.)
5995-926-0833		1	Cable Assembly, Special Purpose, Electrical CX-11416/U: (10 ft)
5995-999-2650		1	Cable Assembly, Special Purpose, Electrical CX-11417: (35 ft 0 in.)
5995-999-2649		1	Cable Assembly, Special Purpose, Electrical CX-11418: (8 ft 6 in.)
5995-926-0835		1	Clamp, Loop: SC-B-19491; 80063
5340-286-2491	3		Connector, Adapter, UG-643/U
5935-259-0019	2		Connector, Adapter, UG-971 /U
5935-201-2410	2		Connector, Adapter, UG-27C/U
5935-204-8382	1		Connector, Adapter, UG-567A/U
5935-201-2735	1		Connector, Adapter, UG-637/U
5935-259-0099	2		Control, Radio Set C-1123/GRC
5820-537-3847	1		Control, Radio Set C-11 23/URC (Modification Kit)
5820-082-3950	1		Control, Remote, C-1474/GRC
5820-503-3468	1		Control, Remote Switching C-1474/GRC: (Modification Kit)
		1	Cord CG-55E/U: (3 ft 4 in.)
5995-889-1314	1		Cord Assembly, Electrical CX-3296/U: (13 ft 6 in.)
5995-523-1789	1		Cord Assembly, Electrical CX-3270/U: (5 ft)
5995-538-9764	2		Cord Assembly, Electrical CX-3271/U: (5 ft)
5995-752-2135	2		Cord Assembly, Electrical: (15 ft 8 in.) SC-C-75544; 80063
6145-283-9634	1		Cord, CD-307A: (6 ft)
5995-164-7716	2		Filter Assembly: SM-D-536227; 80063
		1	Filter Assembly: SM-D-536226: 80063
		1	Filter: 109-D50-52; 02777

Change 1-2.1

FSN.	QUANTITY		Nomenclature, part No., and mfr code
	AN GRC-26D	AN/GRC-26D with MWO	
5815-519-6962	1	1	Frequency Shift Converter, CV-116/URR, CV-1 16A, B, C/URR
5975-193-6774	3		Guy: (11 ft 5 in.) SC-B-28062; 80063
5820-322-4881	1		Handset Box: SC-C-75530B; 80063
5965-504-6370	1		Headset, H-I 13/U
4520-224-7909	1		Heater, Space Electric: AAT-15-A; 72143
4720-520-1995	1		Hose, Air Duct: 996-9; 79132
5970-284-8920	1		Insulator, Bowl: S-SF; 76626
	12		Insulator, Strain: NS4B5224; 81349
5895-922-8755		1	Interconnecting Box J-2623/GRC: SM-D-536241; 80063
5895-922-8746		1	Interconnecting Box J-2624/GRC: SM-D-536193; 80063
5815-839-0283		1	Interconnecting Box J-2597/GRC
5815-839-0284		1	Interconnecting Box J-2598/GRC
5805-503-3395	1		Key KY-116/G
5995-171-3090	1		Lead, Electrical: (3 ft 6% in.) SM-B-125293; 80063
5995-279-2576	1		Lead, Electrical: (10 ft) WS-A4024; 05690
5965-347-0231	1		Loudspeaker Assembly, LS-206/U; LS-206A/U
5985-507-6261	6		Mast, AB-155/U, AB-155A, B/U
5920-497-8634	1	1	Carrying Device MX-387/GRA4: SC-D-28057
5820-221-1563	1	1	Cover CW-124/GRA4: SC-D-28056
5325-497-8640	4	4	Guy Fastener MX-379/U: SC-D-28050
5820-224-4638	3	3	Guy Plate MX-378/U: SC-B-28049
5975-503-0702	4	4	Guy MX-381A/GRA4: SC-D-28053
5975-538-0199	4	4	Guy MX-382A/GRA-4: SC-D-28053
5975-503-0733	4	4	Guy MX-383A/GRA4: SC-D-28053
5985-228-8064	1	1	Halyard MX-516A/GRA-4: SC-D-28054
5120-203-4656	1	1	Hammer, engineers, Double Face 2 1/2 lb; GGG-H-86, Type X, Class 1
5820-240-8233	1	1	Mast Base AB-154/U: SC-DL-182925
5985-636-2420	1	1	Plate, Mast Base: SC-B-84299
5820-227-7168	8	8	Mast Section MS-44: SC-D-1155
4030-187-5263	4	4	Guy Stake; Metal; 18 1/4 in. lg: SC-DL-33399
5510-187-5267	4	4	Stake, Wood; 1 1/2 in. dia X 30 in. lg.: SC-C-22005
5985-453-9439	1	1	Tripod Adapter Mast AB-1089()/U: DL-SC-B.459357
5820-078-4770	2		Mast Base MP-65B
5820-221-5551	1		Mast Base MP-76
5820-199-8831	7		Mast Section MS-1 16A
5820-199-8843	3		Mast Section MS-117A
5985-199-8841	3		Mast Section MS-1 18A
5965-194-9770	1		Microphone M-29/U
5820-537-3869	1		Modulator, Radio Transmitter, MD-239/GR, MD-239A/GR
4520-186-9465	1		Mounting: 2611; 72143
5815-839-0299		1	Mount MT-3298/GR: SC-D-379922; 80063
		1	Platform Assy: SC-D.480935; 80063
5820-538-7555	2		Radio Receiver, R-390A/URR
5820-237-8438	2		Rack, Electrical, MT-655/GRC
8130-174-0812	2		Reel Wire RL-159/U
5820-030-2969	2		Reel RL-29
5815-839-0300		1	Filter-Polar Relay F-1084/GRC: SM-D-536232; 80063
5815-503-2760	1		Reperforator, Transmitter, TT-76/GGC
5410-132-6679	1		Shelter, Electrical Equipment S-56/G, S-56A/G
5940-577-7076	12		Splice Conductor: KS-90; 09922
6625-682-4464	1		Standing Wave Ratio, Power Meter, ME-1 65/G
5930-548-6806	1		Switch Box SA-331/U
5820-947-3253	1		Switch, Electric SA-1 235/GRC-26D: SC-D480956; 80063
5805-543-0012	2		Telephone Set TA-312/PT
5815-557-5970	2		Teletypewriter Set AN/UGC4
5815-392-7743	2		Teletypewriter Set AN/FGC-20X
5820-503-2640	1		Transmitter, Radio T-368/URT, T-368A, B, C, D, E/URT
5820-681-9824	1		Tuner, Radio, TN-339/GR
6145-160-5058	500 ft		Wire, Electrical W-146
	5		Paper, Teletype: UU-P547E; 82865

Change 2 1-2.2

FSN.	QUANTITY		Nomenclature, part No., and mfr code
	AN GRC-26D	AN/GRC-26D with MWO	
5815-503-2621 5815-503-1530 7530-634-6237	2 1 15		Table, Teletypewriter FN-59/FG Table, Teletypewriter, FN-64/MGC Tape, Recording: UUT-T-120:82869

NOTE

For requisitioning purposes, the Federal stock number must be converted to the National stock number by adding "-00-" after the Federal stock classification (FSC) code (first four digits). For example, FSN 58155196962 converts to NSN 581500-519-6962.

Change 2 1-2.3

1-5.2. Expendable Consumable Items

A list of expendable consumable items required for operation appears in table 1-1 and are required for operation of this equipment. They are authorized to be requisitioned by SB 700-50. The FSN for the applicable unit of issue required can be found in appropriate supply catalogs. The FSCM is used as an element in item identification to designate manufacturer, distributor, or Government agency, etc, and is identified in SB 70842.

Table 1-1. Expendable Consumable Supplies and Material

<i>Item</i>	<i>Description</i>	<i>Ref No. and FSCM</i>	<i>FSC</i>
1	Adhesive	4-752; 22428	8150
2	Clip, Paper		4290
3	Clip, Paper		4290
4	Cord, Cotton		3404
5	Oil, Lubricating	644A; 96906	
6	Paper, Teletype	00-P547E 82865	
7	Pencil		8697
8	Tape, Recording	UU-T-120; 82869	6237

Change 1 1-2.4

1-5.2. Expendable Consumable Items

A list of expendable consumable items required for operation appears in table 1-1 and are required for operation of this equipment.

The FSN for the applicable unit of issue required can be found in appropriate supply catalogs. The FSCM is used as an element in item identification to designate manufacturer, distributor, or Government agency, etc, and is identified in SB 70842.

Table 1-1. Expendable Consumable Supplies and Material

<i>Item</i>	<i>Description</i>	<i>Ref No. and FSCM</i>	<i>FSC</i>
1	Adhesive	4-752; 22428	8150
2	Clip, Paper		4290
3	Clip, Paper		4290
4	Cord, Cotton		3404
5	Oil, Lubricating	644A; 96906	
6	Paper, Teletype	00-P547E 82865	
7	Pencil		8697
8	Tape, Recording	UU-T-120; 82869	6237

Change 4 1-2.5

1-6. Nomenclature and Common Names

A list of the nomenclature assignments for those components of Radio Set AN/GRC-26D that are assigned common names is given below. The power units listed are not part of Radio Set AN/ GRC-26D but may be used with it.

<i>Nomenclature</i>	<i>Common name</i>
Cabinet, Electrical Equip-ment CY-1807/G.	Equipment cabinet
Cabinet, Storage CY-1721 (*)/GRC.	Storage cabinet
Control, Radio Set C 1123/GRC.	Control unit
Control, Remote switching C1474/GRC.	Remote control unit
Converter, Frequency Shift CV-116(*)/URR.	Converter
Generator Set, Gasoline Engine, Trailer Mounted PU-619/M	Power unit
Headset, Electrical H-113/U.	Headset
Key, Telegraph KY-116/U	Key
loudspeaker Assembly LS-206(*)/U.	Speaker assembly
Microphone M-29(*)/U	Microphone
Modulator, Radio MD-239(*)/GR.	Fsk-modulator
Radio Set AN/GRC-26D	Radio set
Receiver, Radio R-390 Receiver (*)/URR.	Receiver
Reperforator-Transmitter, Teletypewriter TT-76 (*)/GGC.	Reperforator
Shelter, Electrical Equip-ment S-56(*)/G.	Shelter
Standing Wave Ratio-Power Meter ME-165/G.	Matching unit
Teletypewriter TT-98(*)/FG.	Page printer
Transmitter, Radio T-368(*)/URT.	Transmitter
Tuner, Radio Frequency TN-339/GR.	Tuning unit

1-7. Radio Set AN/GRC-26D

a. The radio set contains two receivers, a transmitter, an fsk-modulator, a converter, a tuning, unit, a control unit, a reperforator, a remote control unit, a power unit, the shelter, two page printers, three whip antennas, and three doublet antennas, interconnecting cables, and accessory components and spare parts. A complete listing of components is in paragraph 1-5.1.

Figures 1-4 through 1-10 show interior views of the shelter.

b. All components of the radio set except the antennas, the remote control unit, and the power unit are housed within the shelter during operation.

c. The radio set can be operated from a remote site with the remote control units (fig. 1-11 and 1-12).

d. The radio set receives its operating power from the trailer mounted power unit.

1-8. Shelter, Electrical Equipment S-56(*)/G

a. The shelter (fig. 1-2 and 1-3) is an insulated steel and plywood structure that houses the components of the radio set. Six wall windows and the window in the rear door have screens and shutters. A roof hatch is provided in Shelter, Electrical Equipment S-56A/G only. The windows and hatch may be opened for ventilation. Interior wiring, electrical outlets, fluorescent lights, a window fan, and a ventilating blower are permanent parts of the 'shelter. Housekeeping and firefighting equipments are mounted in the shelter.

b. The power for the operation of the radio set is connected to the shelter circuit breakers through the power input feedthrough receptacle mounted in the rear wall of the shelter. The circuit breaker housing contains eight circuit breakers (fig. 1-9). Two are high current circuit breakers for the main alternating current (ac) line; four are low current circuit breakers; one is for the transmitter; one is for ,lights; one is for the heater and fans; one is for the remainder of the equipment; two are not connected.

c. The shelter is mounted on a standard 80- by 144-inch cargo truck body for transportation or mobile operation. Lifting straps (fig. 1-3) are used when hoisting the shelter onto the truck. Two holddown assemblies on each side of the shelter secure it to the cargo truck body. Four anchor rings secure the shelter to the cargo truck if the truck bed is a wooden platform.

d. The connections between the doublet antennas and the receivers are made through the receiving doublet antenna feedthrough receptacle (fig. 1-2) on the front wall of the shelter. The connections to the remote line are made through the remote control unit feedthrough receptacle in the curbside wall of the shelter. Connections to the whip antennas are made through feedthrough receptacles in each whip mount

ing bracket. Two Mast Brackets MP-50-(*), which support the receiving antennas, are secured to the front wall of the shelter. Bracket MT657/GRC, which supports the transmitting antenna, is secured to the rear wall of the shelter.

1-9. Blower Assembly, Electrical HD-223/G
(fig. 1-4)

Blower Assembly, Electrical HD-223/G, mounted in the equipment cabinet, provides air circulation for the equipment mounted in the equipment cabinet.

1-10. Control, Radio Set C-1 123/GRC
(fig. 3-2, 3-3)

a. The control unit (fig. 1-4) is the control center for the radio set. The control unit routes the signals to be transmitted or received to the proper components of the radio set for each particular type of operation (fsk, am, voice, cw, fsk am., and cryptographic (crypto)). The control unit receives mark and space signals from-

converter and directs them to the teletypewriter equipment through Junction Boxes J-2597/GRC and J-2598/GRC. The control unit receives signals originating from the teletypewriter equipment, and directs them from Junction Boxes J2597/GRC and J-2598/GRC to the fsk-modulator; signals initiated by the microphone, telephone, or key are directed to the transmitter. During operation with crypto equipment, the signals are routed through the crypto equipment instead of Junction Boxes J-2597/GRC and J2598/GRC.

b. The control unit is housed in a smooth, gray-enameled metal case and mounted on the curbside wall above the teletypewriter equipment. The operating controls are on the front panel. The top and two sides of the control unit contain jacks and binding posts for connections to the other equipments of the radio set.

1-11. Converter, Frequency Shift CV-1 16(*)/ URR
(fig. 1-4)

The converter, mounted in the equipment cabinet, converts frequency-shifted signals into direct current (dc)

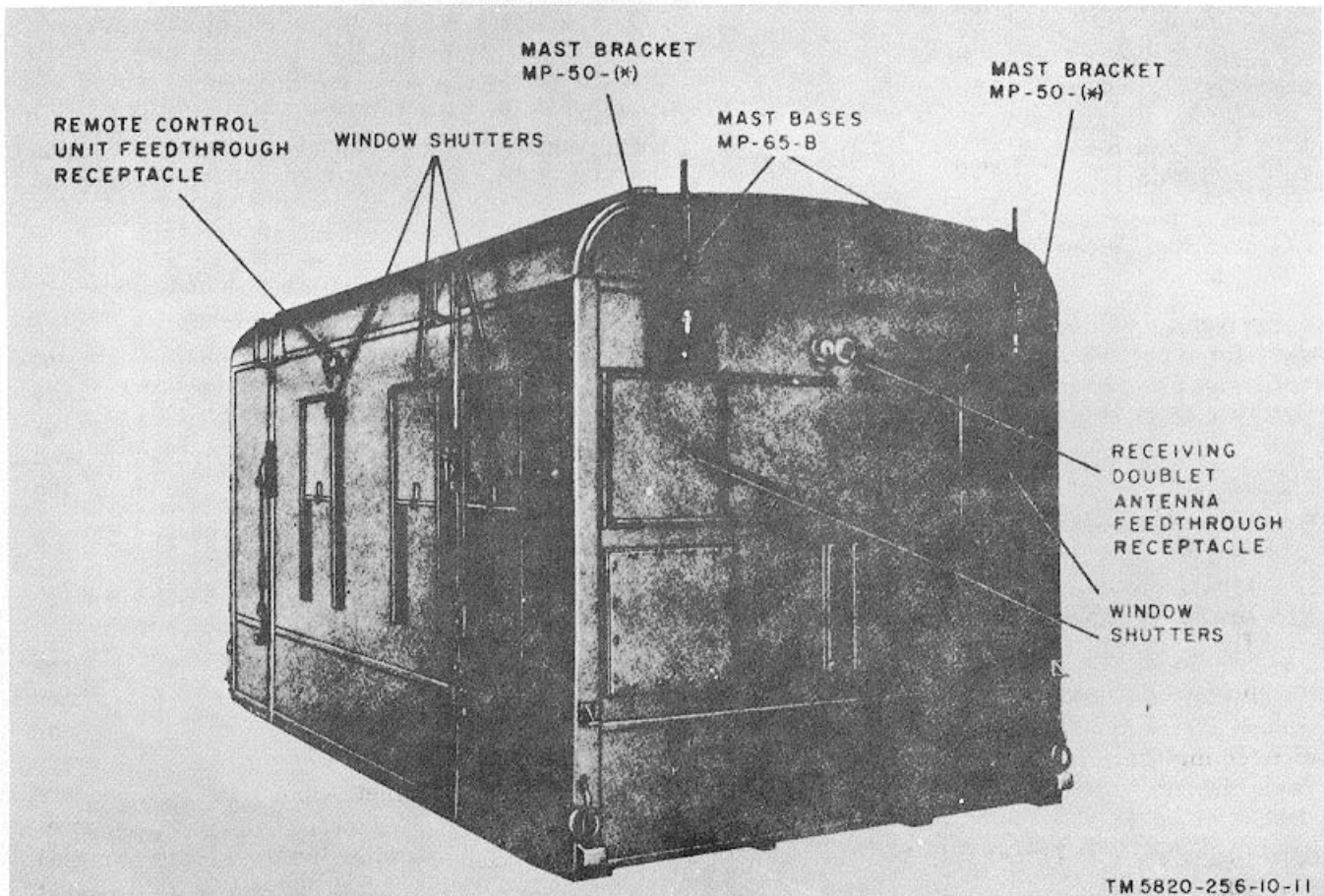

Figure 1-2. Shelter, Electrical Equipment S-56(*)/G, front oblique view.

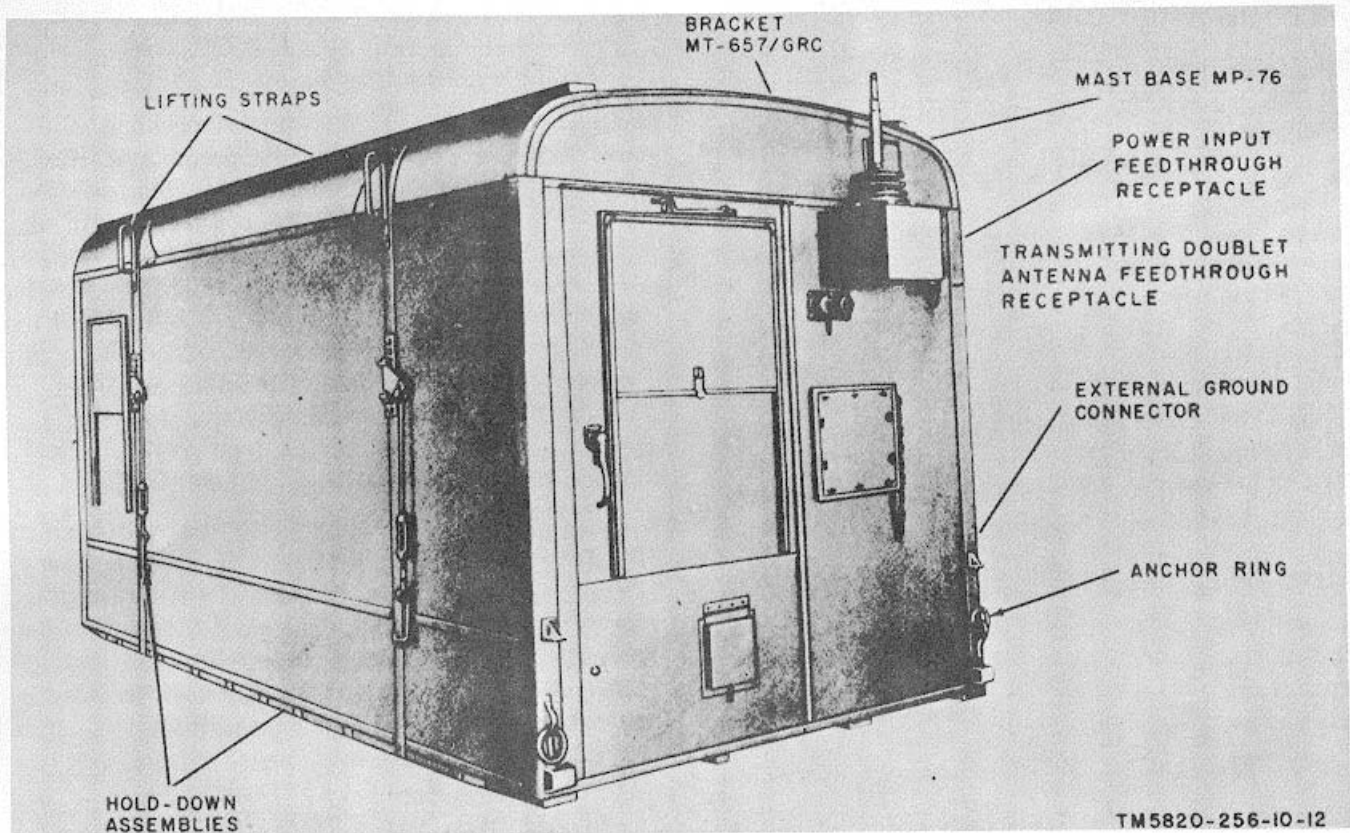

Figure 1-3. Shelter, Electrical Equipment S-56(*)/G, rear oblique view.

pulses. Refer to TM 11-2241 for a detailed description.

1-12. Receiver, Radio R-390(*)/URR
(fig. 1-4)

Two receivers, mounted in the equipment cabinet, provide for reception of cw, am. voice, fsk, and fsk-am. signals within a frequency range of 0.5 to 32.0 MHz. For a detailed description of the R-390/URR, refer to TM 11-5820-357-10. For a detailed description of the R-390A/URR, refer to TAI 11-5820-358-10.

1-13. Reperforator-Transmitter, Teletypewriter TT-76(*)/GGC
(fig. 1-4 and 1-9)

The reperforator, mounted on Teletypewriter Table FN-64/MGC, transmits and receives teletypewriter messages. Refer to TM 11-5815-238-12 for a detailed description.

1-14. Teletypewriter TT-98(*)/FG
(fig. 1-4)

Two page printers, mounted on Teletypewriter Tables FN-59/FG adjacent to the curbside wall,

transmit and receive teletypewriter messages. Refer to TM 11-5815-200-12 for a detailed description.

1-15. Loudspeaker Assembly LS-206(*)/U
(fig. 1-4)

The speaker assembly, mounted in the equipment cabinet, provides a means by which the audio signals may be monitored. The speaker assembly houses two 6-inch speakers, the transformers, and the selector switches, which are mounted on the front panel.

1-16. Modulator, Radio MD-239(*)/GR
(fig. 1-9)

The fsk-modulator provides the required frequency shift for radio transmission of teletypewriter signals. The fsk-modulator is bolted to the top of the transmitter. It is contained in a smooth, gray-enameled metal cabinet. Operating controls are on the front panel. A power input jack, a blower jack, and a teletypewriter input jack are mounted on the rear of the chassis. A blower is mounted on the rear of the cabinet; ventilation screens are near the front of the cabinet.

1-17. Transmitter, Radio T368(*)/URT (fig. 1-9)

The transmitter is used for the transmission of cw, am, voice, fsk, and fsk-am. signals within a frequency range of 1.5 to 20 MHz. Refer to TM 11-809-10 for a detailed description.

1-18. Standing Wave Ratio-Power Meter ME-1 65/G (fig. 1-9)

The matching unit, mounted on the curbside wall, provides a noninductive dummy load of 52 ohms. It permits direct readings of the transmitter power output and the standing wave ratio (swr) between the transmitter and its load. Refer to TM 11-6625-233-15 for a description.

1-19. Tuner, Radio Frequency TN339/GR (fig. 1-9)

The tuning unit, mounted on the top of the transmitter, provides a means of adjusting the electrical length of the transmitting whip antenna. Refer to TAI 11-809-10 for a detailed description.

1-20. Telephone Set TA-312/PT

Telephone Set TA-312/PT is mounted in the handset box, which is secured to the forward side of the storage cabinet. The TA-312/PT provides telephone facilities between radio sets. On early orders of the radio set, Telephone Set TA-43/ PT was used. For a detailed description of the TA-312/PT, refer to TM 11-5805-201-12. For a detailed description of the TA-43/PT, refer to TAI 11-337.

1-21. Control, Remote Switching C-1474/GRC (fig. 1-11 and 1-12)

The remote control unit controls the operation of the radio set from a remote site. The remote control unit consists of binding posts and jacks in a metal housing. On the right panel are four sets of binding posts: ONE WAY, REMOTE TEL., REC. DX, and LOCAL TEL. The XMTR ON switch is on the front panel, and six telephone jacks are on the left panel. The TTY SWITCH coaxial connector is below the telephone jacks. A bracket at the top of the unit is for mounting the remote control unit. The modified remote control unit (fig. 1-12) has three jacks and two connectors on the right panel. The jacks are labeled LOC TEL, REC DX, and ONE WAY OR SEND DX. The connectors are labeled REMOTE and TTY SWITCH. The XMTR ON

switch is on the front panel. A bracket at the top of the unit is for mounting the unit.

1-22. Interconnecting Box J-2623/GRC (fig. 1-13 and 1-14)

During remote operation, Interconnecting Box J2623/GRC provides termination points from Control, Radio Set C-1123/GRC, located in the shelter, to Interconnecting Box J-2624/GRC at the remote site. Three cables from the shelter are connected to connectors J1, J2, and J3 of the J-2624/GRC at the remote site. The back plate of the J-2623/GRC is designed in the form of a hook for mounting outside the shelter.

1-23. Interconnecting Box J-2624/GRC (fig. 1-15)

Interconnecting Box J-2624/GRC is used during remote operation to accept field wire connections to its binding posts E1 through E7 from binding posts E1 through E7 of Interconnecting Box J2623/GRC and to provide termination for a cable from the J-2623/GRC to Control, Remote Switching C-1474/GRC at the remote site.

1-24. Junction Box J-2597/GRC (fig. 1-8)

Junction Box J-2597/GRC has five connectors and five binding posts. The connectors are designated J3 LOOP IN 1, J7 LOOP OUT 1, J4 LOOP IN 1, J8 LOOP OUT 2, J9 TRANS VOICE GRD. The binding posts are designated E1, E2, E3, E4, and E5. The J-2597/GRC is used between the teletypewriter equipment and Control, Radio Set C-1123/GRC to provide through connections when security equipment is not being used. Four captive screws fasten this unit to the center shelf of the equipment rack.

1-25. Junction Box J-2598/GRC (fig. 1-8)

Junction Box J-2598/GRC has two connectors and three binding posts. The connectors are designated J7 LOOP OUT 1 and J8 LOOP OUT 2.

The binding posts are designated E1, E2, and E3.

The J-2598/GRC is used between the teletypewriter equipment and Control, Radio Set C-1123/ GRC to provide through connections when security equipment is not being used. Four captive screws fasten this unit to the equipment rack.

1-26. Deleted.

1-27. Generator Set, Gasoline Engine, Trailer Mounted

Power requirements for the AN/GR-26D are usually satisfied by the use of two 10 kw, gasoline powered, motor generator sets, with accessories, mounted on a 1-1/2-ton trailer. The PU-619M (TM 56115275-15 and TM 52805259-14) or equivalent may be used.

1-28. Operating Accessories

a. *Headset, Electrical H-113/U* (4, fig. B-12). The headset consists of two earphones mounted on an adjustable headband and a connecting cord and plug that extends 18 inches from the right earphone. The earphones are provided with rubber cushions. On an early order of the radio set, Headset, Electrical (Navy type 49507) was supplied, which may be used interchangeably with the H-113/U.

b. *Microphone M-29(*)/U* (7, fig. B-4). The microphone is a unidirectional, low-impedance, carbon button, handheld microphone. It is provided with a cord terminated in an adapter plug at one end and in the microphone through a switch at the other end. A metal hanger is at the top of the handle. The microphone is connected to the MIC OR KEY jack on the control unit and operated by the press-to-talk switch on the handle.

c. *Key, Telegraph KY-116/U* (4, fig. B-4). The key is attached to a metal clamp that can be mounted on the operator's leg. The key is equipped with four brass screws for mechanical adjustments and two brass screws for connecting the key to Cable Assembly, Special Purpose, Electrical CX-1852/U. On an early order of the radio set, Key J-45 was supplied. The J-45 is connected to Cord CD-201 which has a plug at the free end.

d. *Whip Antennas*. One transmitting and two receiving whip antennas are furnished.

(1) Each receiving whip antenna consists of two Mast Sections MS-116A, one Mast Section MS-117-A, and one Mast Section MS-118-A, which are assembled and inserted in Mast Base MP-65B. Mast Base MP65-B is mounted on Mast Bracket MP-50-(*), which is secured to the front exterior wall of the shelter (fig. 1-2). The whips are tied down with insulated guy assemblies when the radio set is operated while in motion.

(2) The transmitting whip antenna consists of three Mast Sections MS-116-A, one Mast Section MS-117-A, and one Mast Section MS-118-A, which are assembled and inserted in Mast Base MP-76. Mast Base MP-76 is mounted on Bracket MT-657/GRC and secured to the outside rear wall of the shelter. An insulated guy assembly is provided to tie the transmitting whip antenna in a horizontal position when the radio set is operated while in motion.

e. *Doublet Antennas*. Six Masts AB-115(*)/U (fig. 1-17) and 1,000 feet of Wire W-1 are furnished for the construction of half-wave doublet antennas. At frequencies from 1.5 to 4.0 MHz, three Masts AB-115(*)/U are used to support each doublet antenna; therefore, two antennas may be erected: one for receiving, and one for transmitting. At frequencies from 4.0 to 20.0 MHz, where shorter wire lengths are required, two Masts AB-115(*)/U are used to support each doublet; therefore, three antennas may be erected: two for receiving, and one for transmitting. Two Cable Assemblies, Radio Frequency CG-1334/U, each 500 feet long, are used for receiving antenna lead-ins. One RF Cable Assembly CG-692/U, 75 feet long, is used as a transmission line for the transmitting doublet. Figure 1-17 shows the components of one complete Mast AB-115(*)/U.

f. *Switch Box SA-331/U*. The SA-331/U (fig. 1-18 and 1-19), used with the motor-generators and mounted on the motor-generator trailer. It enables the operator to switch from one motor-generator to the other without interrupting the operation of the radio set. The SA-331/U is almost cubical. It is secured in its case by six captive screws on the front and eight captive screws at the rear. The input and output connectors are at the rear of the SA-331/U.

1-29. Nonoperating Components

a. *Cabinet, Electrical Equipment CY-1807/G* (fig. 1-4). The metal equipment cabinet is a rack-type cabinet that houses the two receivers, a converter, a speaker assembly, and Blower Assembly, Electrical HD-223/G. The equipment cabinet is shock mounted to the floor and wall of the shelter. A stainless-steel utility table can be fastened to the front of the equipment cabinet at the correct servicing height for the three major components in the equipment cabinet. When not in use, the utility table is attached to the shelter wall by brackets.

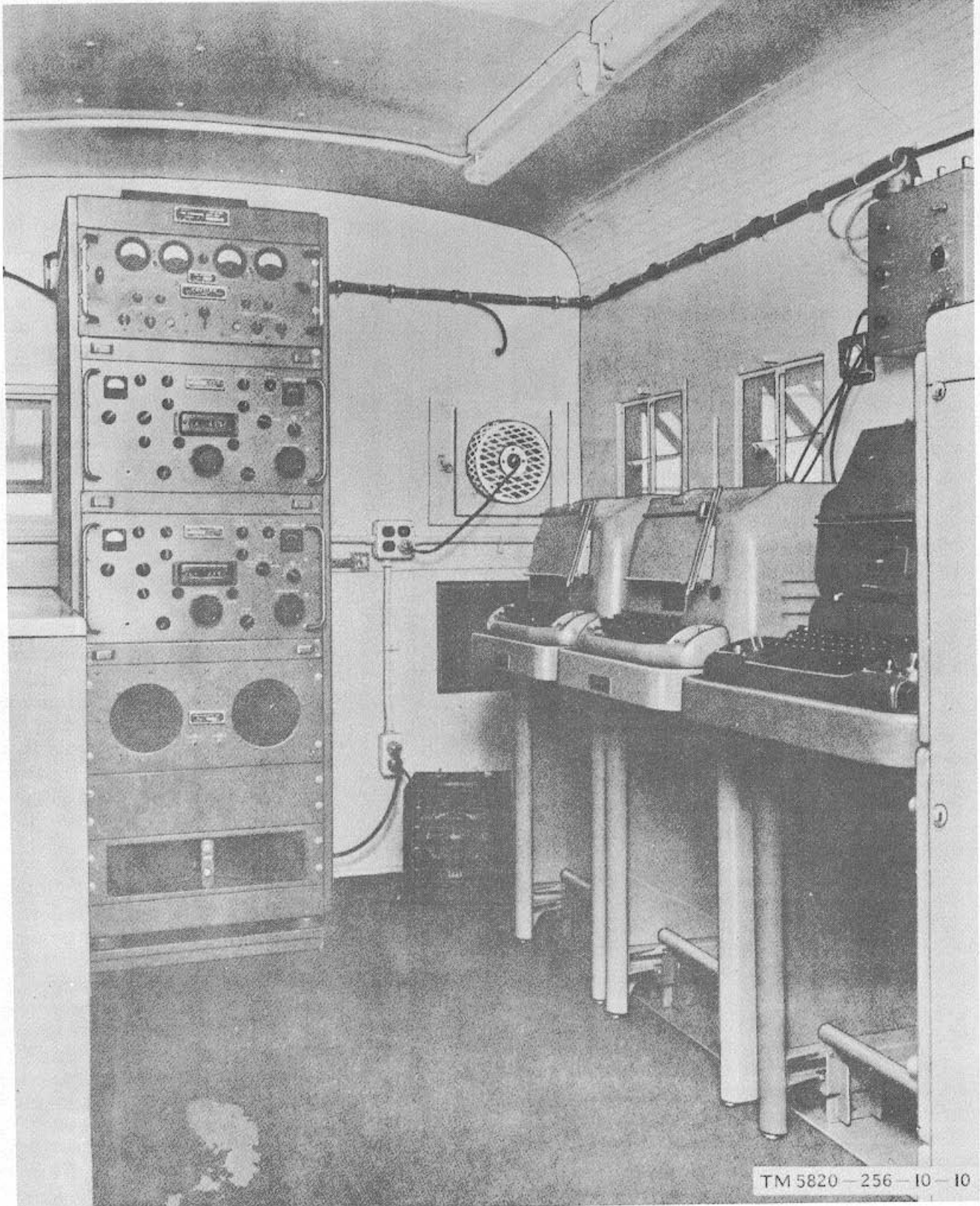

Figure 1-4. Radio Set AN/GRC-26D, interior front view.

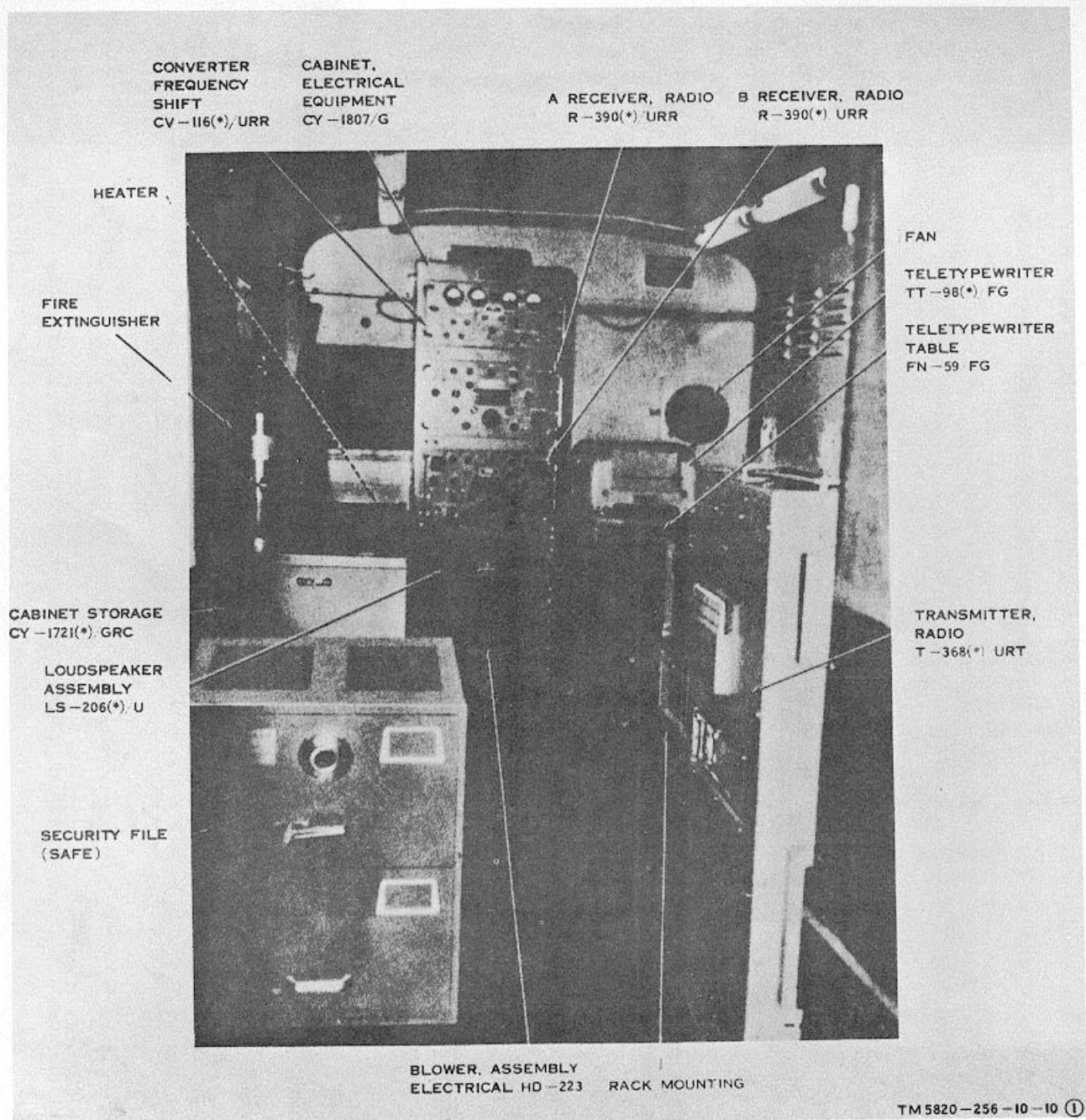

Figure 1-5. Radio Set A N/GRC-26D, interior view from rear door (modified per MWO 11-5820-256-35/1).

b. *Cabinet, Storage CY-1721(*)/GRC* (fig. 1-4)
 The storage cabinet is adjacent to the roadside wall of the shelter and is secured to the shelter floor and wall by rotolock fasteners. The metallic cabinet has an exterior finish of smooth, gray enamel. The tabletop of the storage cabinet is of Formica material. Sliding drawers with rollers provide storage for minor components and accessories of the radio set.

c. *Clock* (fig. 1-4). The clock is mounted in a metal case. The mounting frame has four holes which are for mounting of the dock on the curt>side wall above the teletypewriter equipment.

d. *Heater* (fig. 1-4). The heater is housed in a black metal case with a cast aluminum grid. It operates on 115-volt, 50- to 60-Hertz (Hz), single-phase ac and consumes 1,500 watts. A thermal reset switch is on the front panel below the grid.

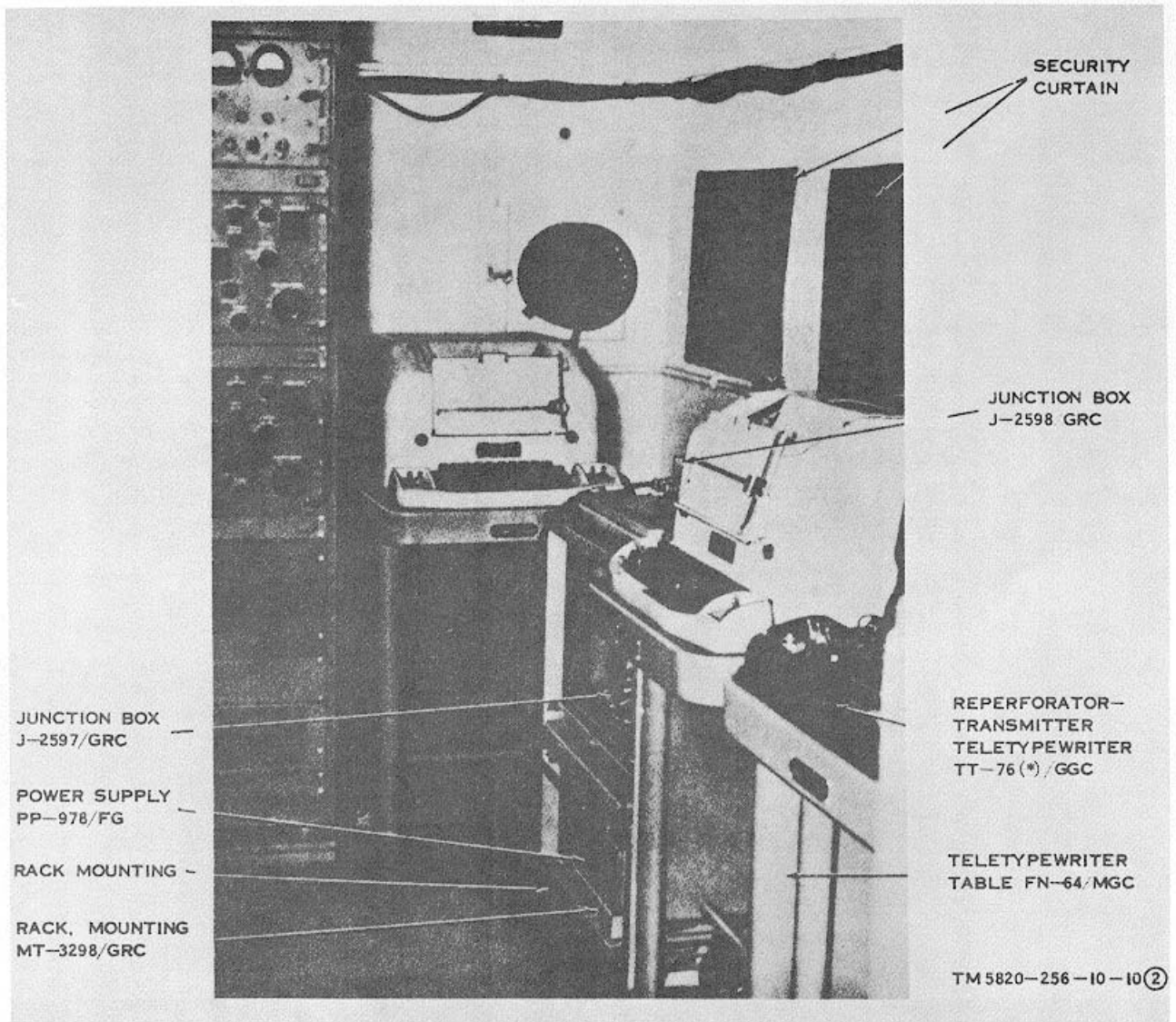

Figure 1-6. Radio Set AN/GRC-26D, interior front view (modified per MWO 11-5820-256-5/1).

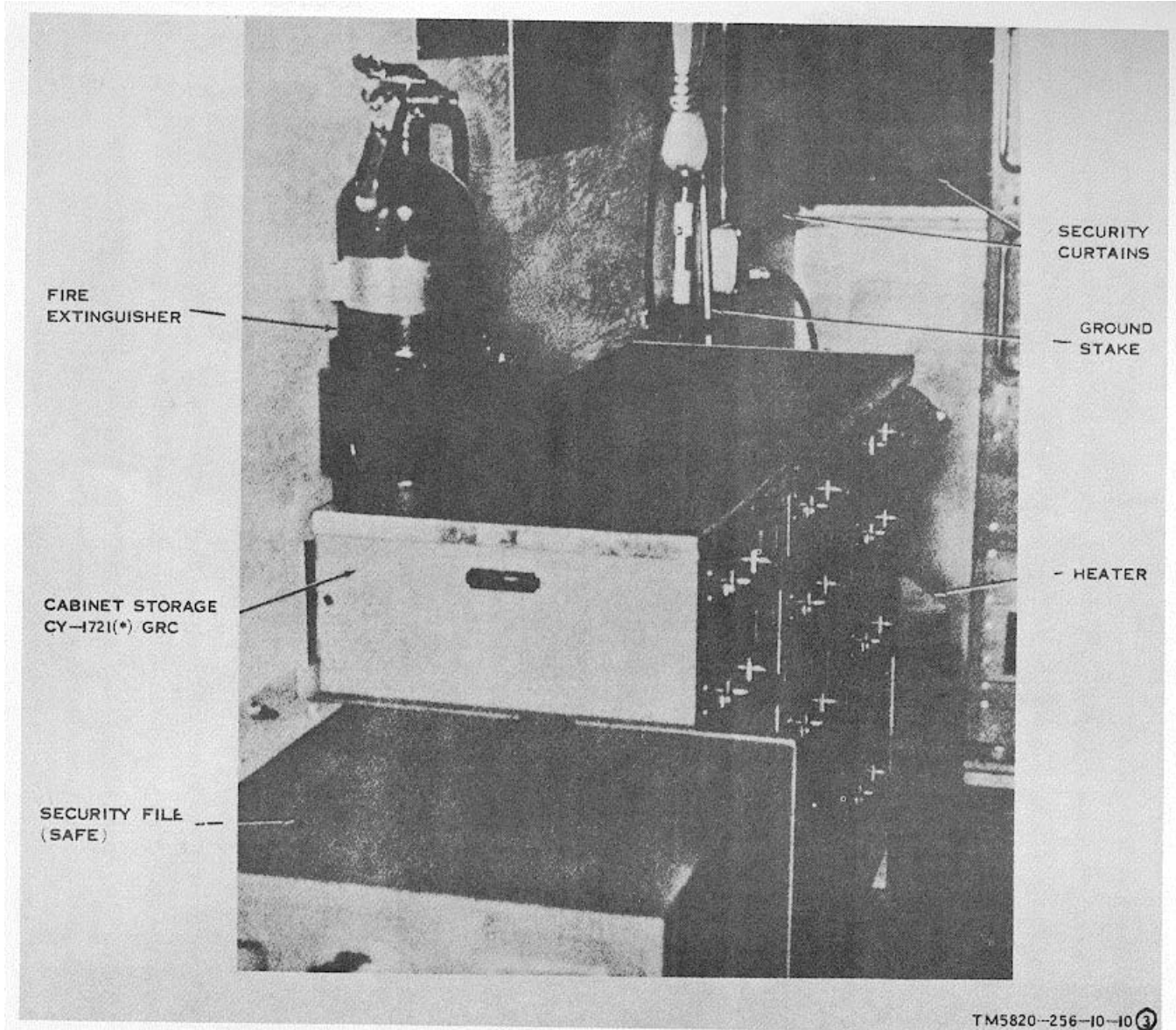

Figure 1-7. Radio Set AN/GRC-26D, interior roadside view from rear door
(modified per MWO 11-5820-256-5/1)

A fan, mounted in front of the heater element, circulates the heated air. A toggle switch on the top panel of the housing allows the fan to be operated independent of heat, but heat cannot be turned on without placing the fan in operation. Four wing-type Dzus fasteners secure the heater to the heater mounting plate which is secured to the floor of the shelter.

e. *Rack, Mounting MT-3298/GRC* (fig. 1-8). Rack, Mounting MT-3298/GRC is a metal rack designed for holding Power Supply PP-978/FG when it is mounted in the equipment rack. Jacks marked AC IN and DC OUT are provided on the -rack.

1-30. Differences in Models

All Radio Sets AN/GRC-26D are similar in purpose and operation. The differences the operator is concerned with are the modern designations of the major components and application of MWO 11-5820-256-35/1. This modification provides Radio Set AN/GRC-26D with a capability for crypto operation. Operating procedures with crypto facility installed are the same as normal operating procedures, except that Switch, Electronic SA-1253/GRC must be operated to the correct position. Although the use of different

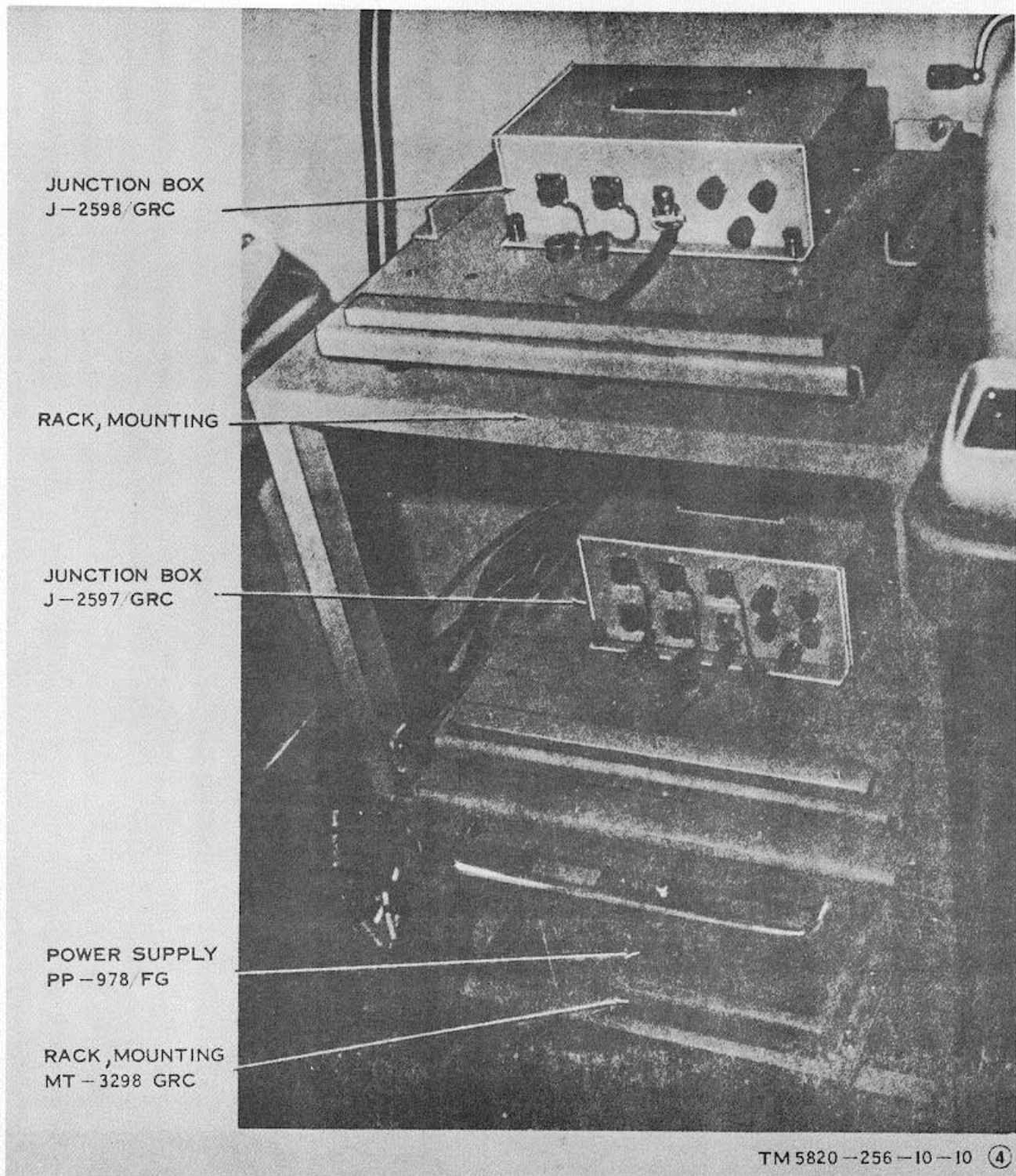

Figure 1-8. Rack mounting equipment

models of the same components may result in minor changes in the operating procedure, these differences are covered in the technical manuals for the individual components (app A).

Other differences between models of the radio set which do not change the operating procedures are listed in the chart below.

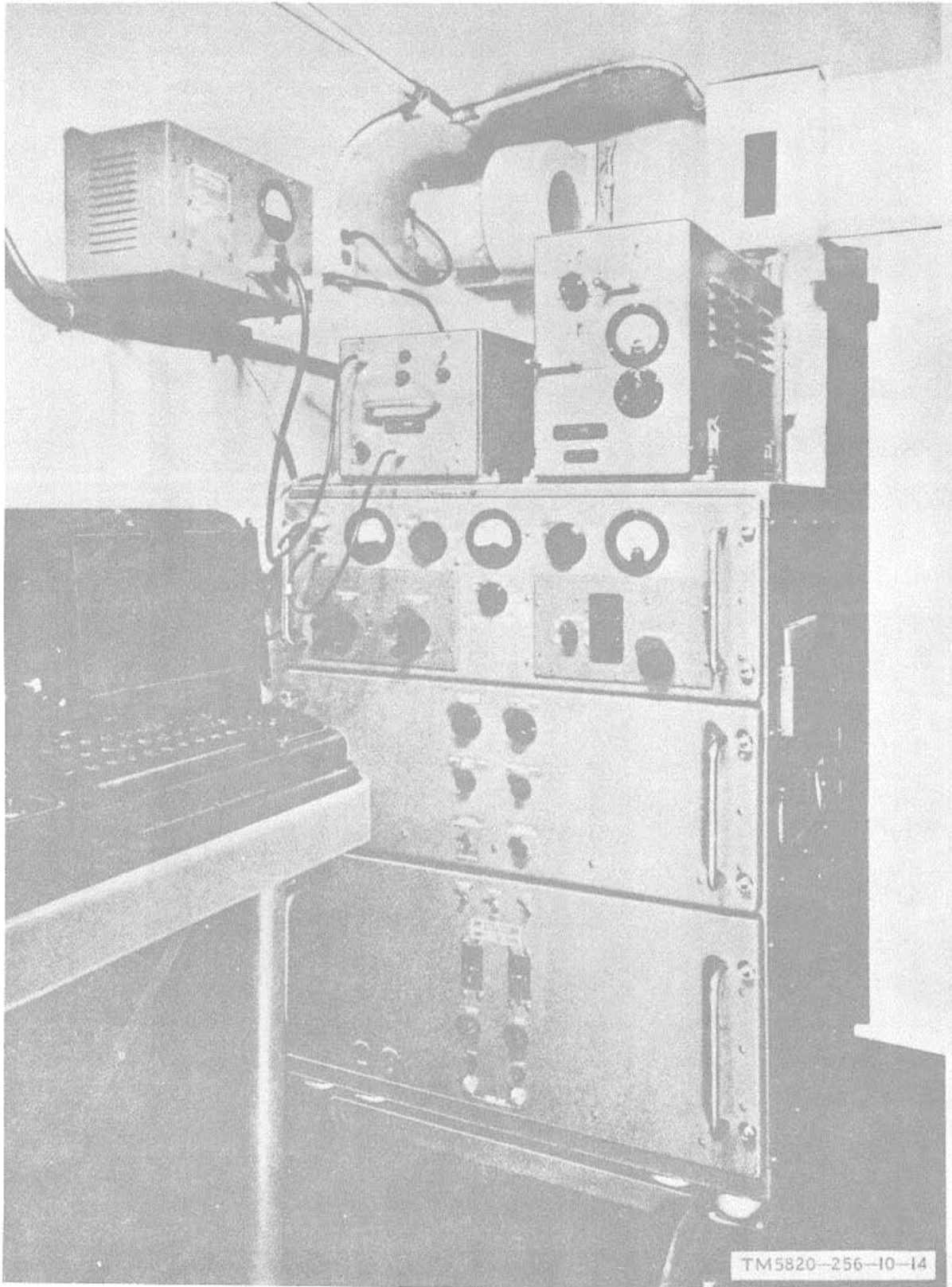

Figure 1-9. Radio Set AN/GRC-26D, interior view.

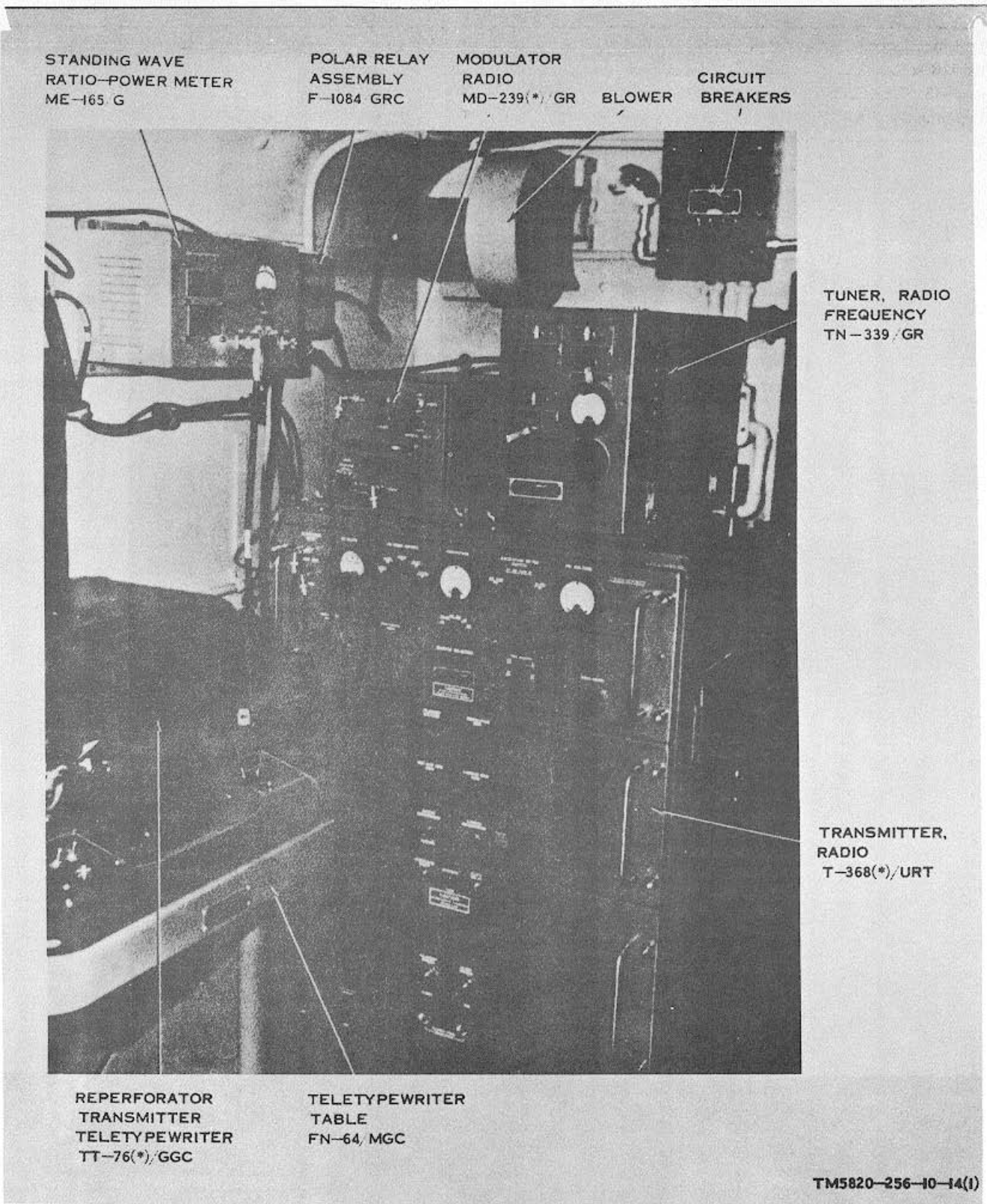
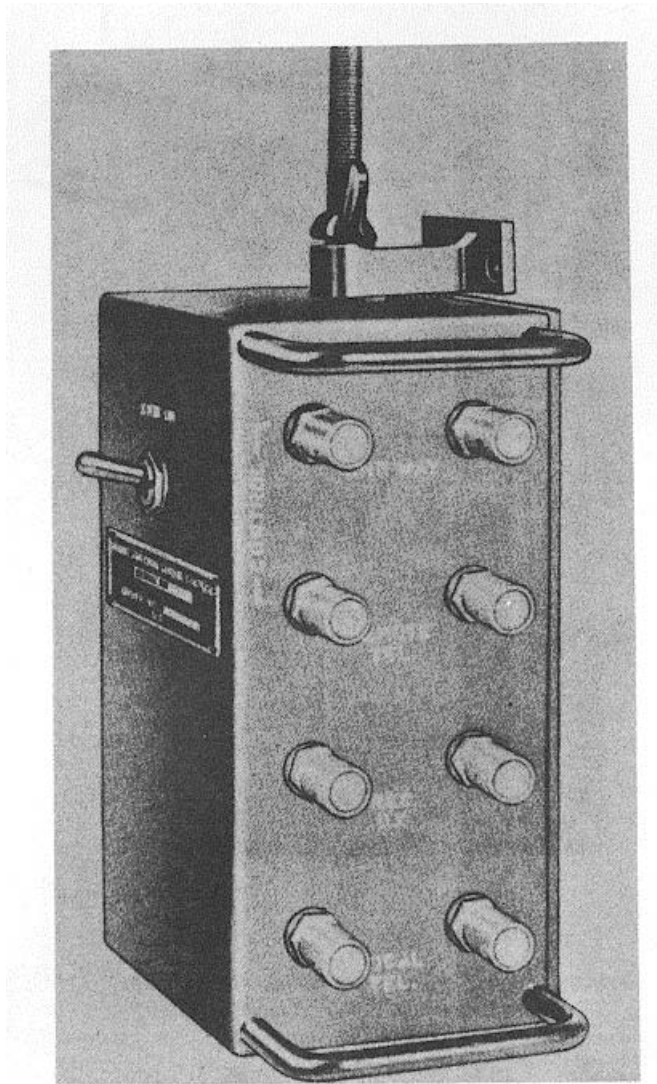

Figure 1-10. Radio Set AN/GRC-26D, interior rear view (modified per MWO 11-5820-256-35-1).

Order No. 25209-Phili-M4	Order No. 28459-Phila-55 and 21316-Phila-56	Order No. 43066-Phil-56 and 3219-PP-59
Headset, Electrical (Navy type 49507)	Headset, Electrical H-113/U	Headset, Electrical H-1113/U.
Reel DR-4	Reel RL-159	Reel RI-159.
Key J45	Key, Telegraph KY-116/U	Key, Telegraph KY-116/U.
Telephone Set TA-43/PT	Telephone Set TA-43/PT	Telephone Set TA-312/PT.



TM5820-256-10-33

Figure 1-11. Control, Remote Switching C-1474/GRC, oblique view.

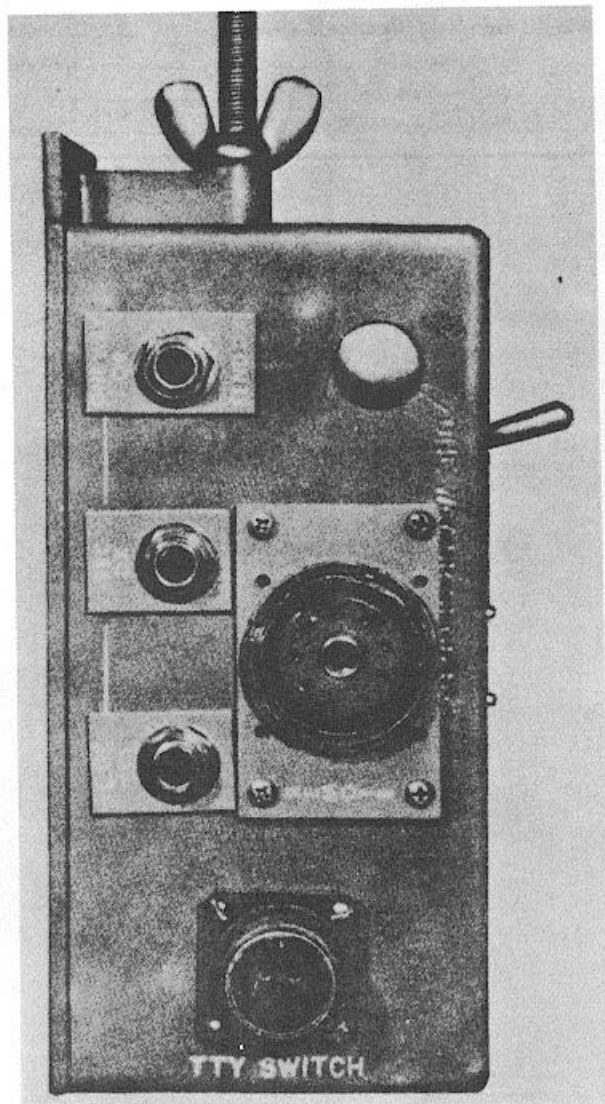

TM 5820-256-10-33(I)

Figure 1-12. Control, Remote Switching C-1474/GRC, left side view (modified per MWO 11-5820-2564-5/1).

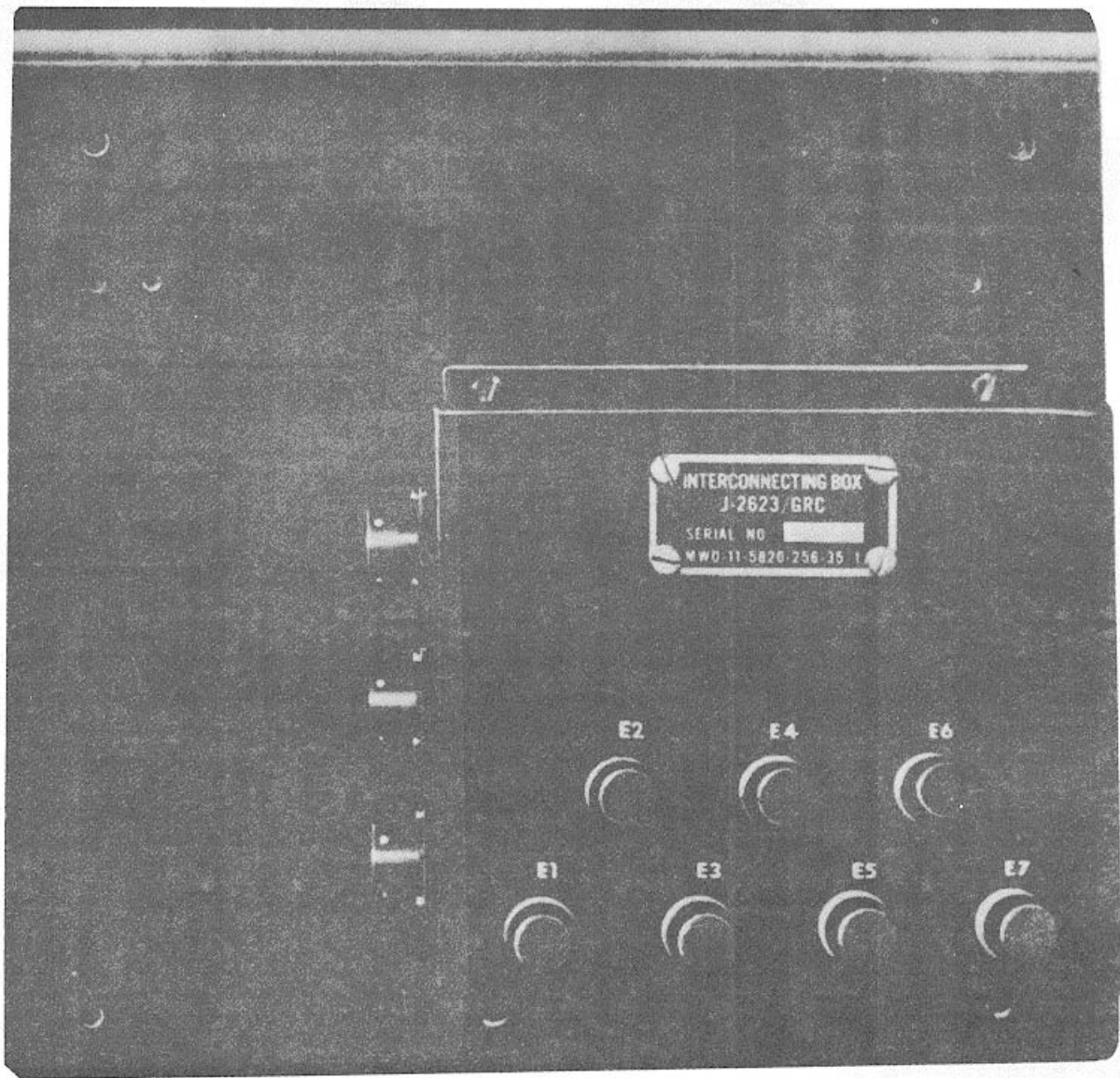

TM 5820-256-10-45

Figure 1-13. Interconnecting Box J-2623/GRC, front view.

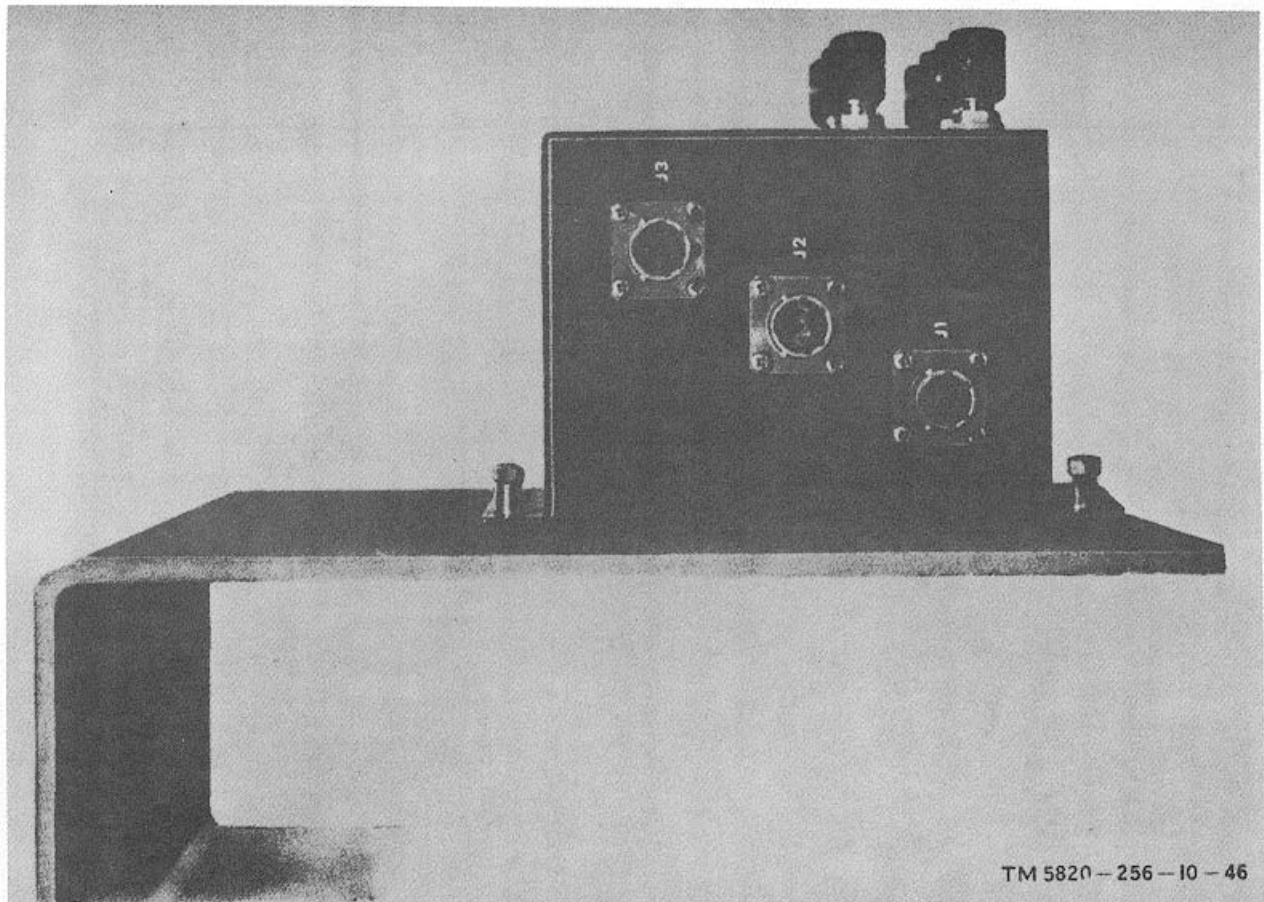

Figure 1-14. Interconnecting Box J-262s/GRC, side view.

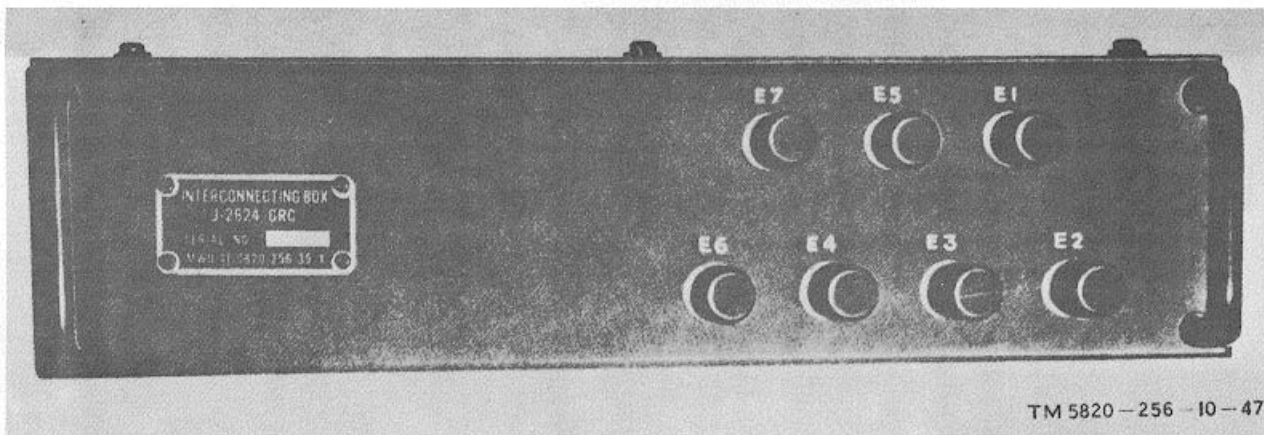

Figure 1-15. Interconnecting Box J-2624/GRC.

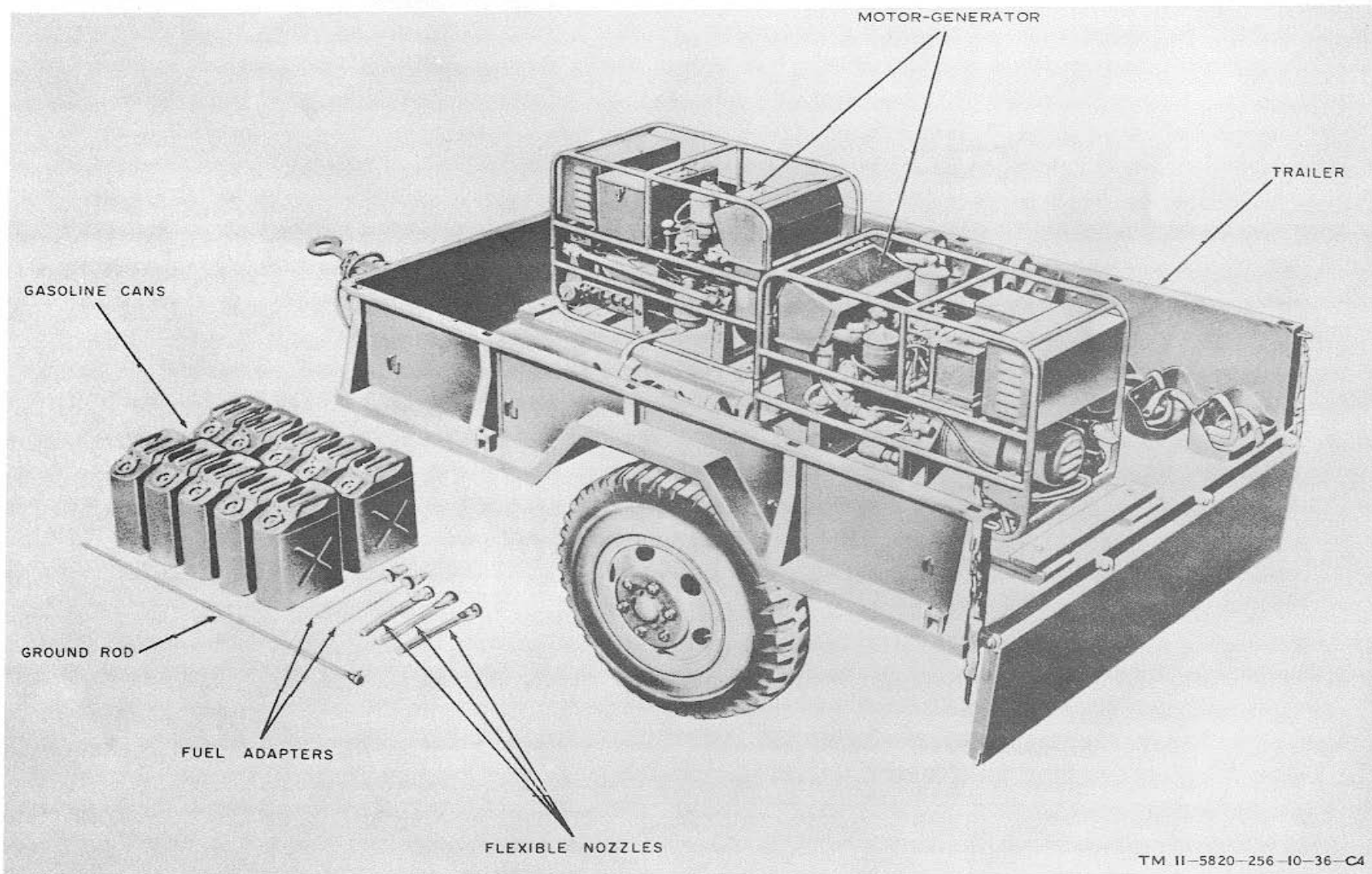

Figure 1-16. Generator set, gasoline engine, trailer mounted (typical), with accessory components.

Change 4 1-19

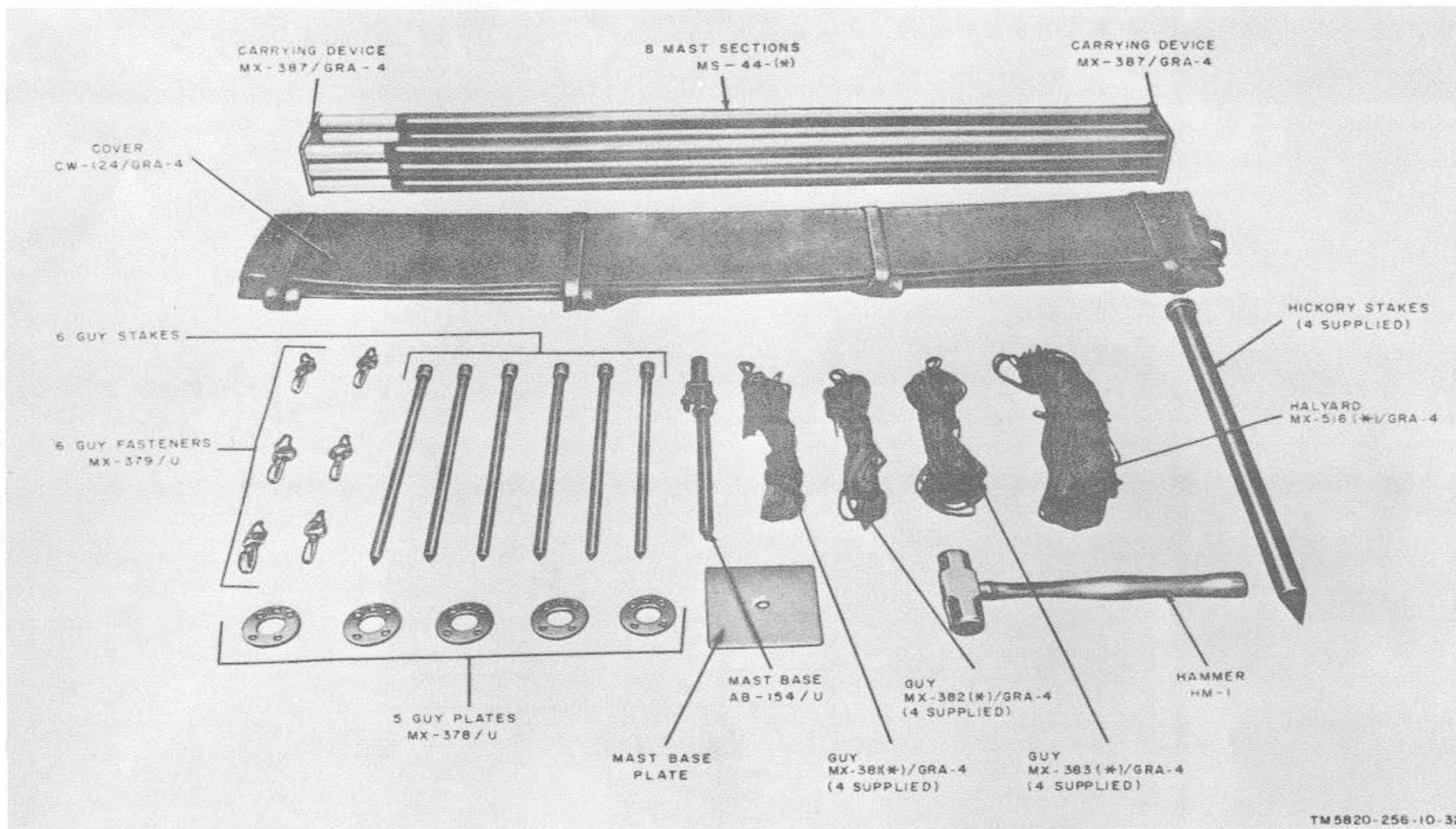

Figure 1-17. Mast AB-155(*)/U, components.

Change 4 1-20

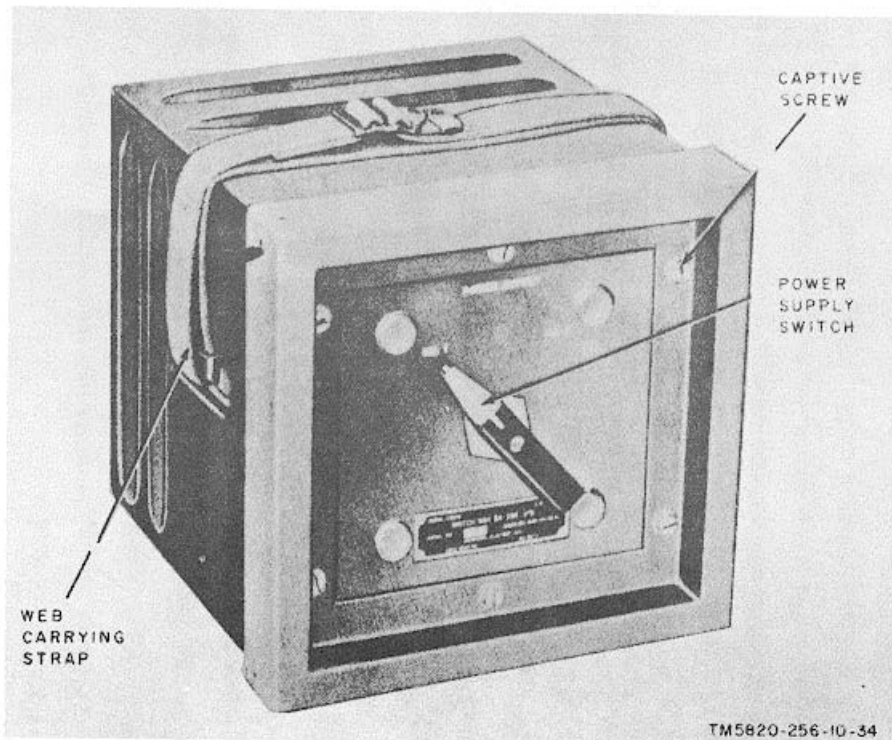

Figure 1-18. Switch Box SA-S11/U, front view.

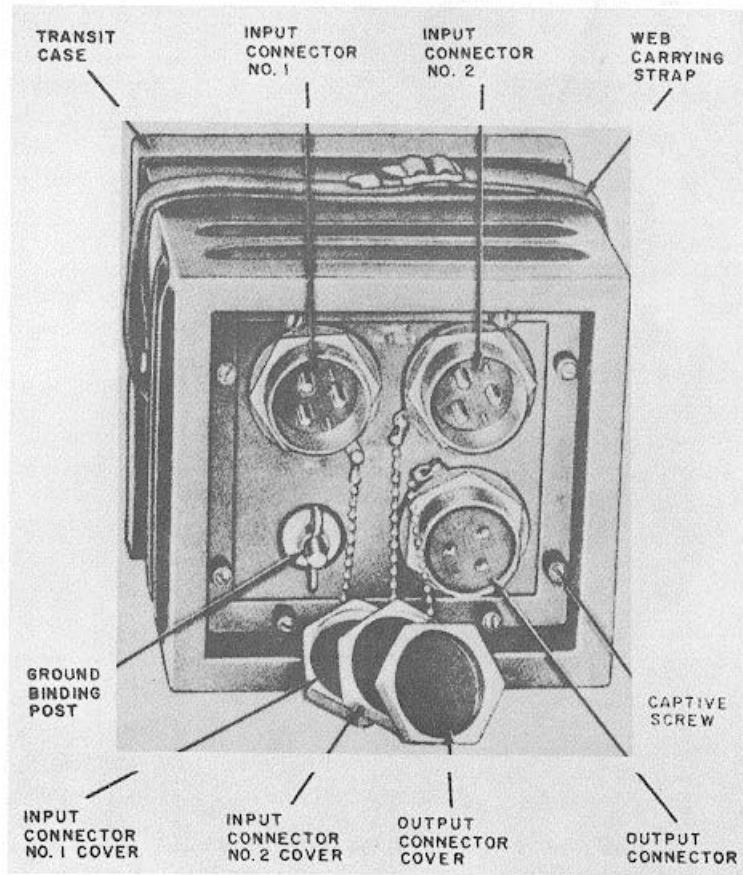

Figure 1-19. Switch Box SA-331/U, rear view.

CHAPTER 2 INSTALLATION

WARNING

During installation of this equipment, conform to all safety requirements in TB SIG 291. Injury or death could result from failure to comply with safe practices.

2-1. Siting

When selecting the antenna site, consider the following:

a. Radio signals are absorbed and sometimes reflected by nearby obstructions, such as hills, metal buildings, and bridges, or by telephone lines that extend above the height of the antenna (fig. 1-1). Transmitted signals have a greater range when the antenna is as high above ground as possible. Transmission and reception are best over water or level ground.

b. If transmission and reception in all directions are required, place the antenna on the highest hill within the designated area.

c. When in rear areas, avoid placing the radio set near sources of electrical interference, such as power or telephone lines and radar equipment.

d. Try several locations within the general area, and select the one that provides the best signals from the desired stations.

e. Enemy jamming action against the receiver is always a possibility. The effects of enemy jamming may be reduced by locating the antenna so that nearby obstructions act as a screen in the direction of probable sites of enemy jamming transmitters. This screening action may also reduce the transmitted signal strength in a direction toward the enemy and thereby make it more difficult for the enemy to intercept the signals.

f. For space diversity reception, a clear area suitable for the erection of two doublet receiving antennas is required. The receiving antennas should be separated by at least three wavelengths or more at the operating frequency, but the separation should not exceed 900 feet. The best reception is possible when the receiving antennas are perpendicular or broadside to the desired incoming signal and in line with transmitted signals from local installations. For each receiving antenna, a clear level area, the size of which is determined by the frequency of operation, is desirable. At 2 MHz, each antenna will require an area of 285 feet by 50 feet, with the long dimension perpendicular to the direction of reception. At 18 MHz, each antenna will require an area of 180 feet by 50 feet. The shelter should be midway between the two receiving antennas.

For a long-wire transmitting antenna, a level area of approximately 200 feet by 40 feet by 40 feet is required. The center of the transmitting antenna should be approximately 30 feet from the shelter.

g. Where a large number of radio sets are in operation, careful layout of the numerous antennas is necessary. Improper layouts will cause mutual interference between the various radio sets. This interference may be great enough to affect the intelligibility of the incoming signals. Mutual interference from nearby transmitters may be reduced by separating the receiving antennas from the interfering transmitting antennas as much as possible. Other means of reducing interference are orienting the antennas to take best advantage of their directional patterns, selecting operating frequencies properly, tuning transmitters accurately, and aligning receivers properly.

2-2. Unpacking

When packed for shipment, the major components, accessories, and spare parts for the radio set are mounted or stored in designated cabinets, compartments, shelf space, or chests within the shelter. The overflow components, accessories, and spare parts are placed within a wooden box. The wooden box is 39 inches long, 23 inches wide, 23 inches deep, and has a volume of 14.5 cubic feet. Cables properly coiled, antenna equipment chests, and the overflow box are stored on the shelter floor. Cabinets and chests are secured with fastening devices. Components on shelves are blocked, braced, tied, or strapped to protect the items against movement and transportation hazards. All shelter windows, blackout blinds, doors, and louvers are closed and secured. Antenna openings and all other openings are covered with caps provided or with properly secured sheet metal plates or wooden plugs.

a. *General.* Be careful in unpacking. Do not thrust tools into the interior of any container or wrap.

b. *Unpacking.* Remove the caps, covers, plates, and plugs from the openings. Open the shelter doors and dismantle the wooden blocking and bracing frames.

Remove and open the overflow boxes. Remove all other ties and blocking material used to secure the components in the shelter.

2-3. Checking Unpacked Equipment

- a. Inspect the equipment for damage that may have been incurred during shipment. If the equipment has been damaged, fill out and forward DD Form 6 (para 1-3b).
- b. Check to see that the equipment is complete as listed on the packing slip.
- c. If the equipment has been reconditioned, see if it has changed by a modification work order (MWO). If modified, the MWO number will appear on the front near the nomenclature plate. Check to see that all the MWO's have been completed. Additional MWO's may need to be performed.

2-4. Installation of Shelter, Electrical Equipment S-56(*)/G

If the radio set is to be used as a mobile station, the shelter should be installed on a 2 1/2 -ton, 6 by 6 cargo truck (fig. 1-1). Use the following procedures for setting up the radio set for mobile use.

- a. Remove the canvas cover and side framing from the truck. Drop the tailgate.
- b. Obtain a hoist capable of lifting the shelter. Lift the shelter by its four lifting straps, and place it on the truck body with the entrance door toward the rear of the truck. If a hoist is not available, skids may be used to slide the shelter onto the truck. Skid Equipment MX-157/U may be used for this purpose.
- c. Attach the holddown clamps on the shelter to the truck body sides to hold the shelter firmly in place. If the cargo truck has a wooden platform, secure the shelter with the four anchor rings (fig. 1-3).
- d. Couple the power unit trailer to the rear of the truck.

2-5. Installation of Whip Antennas

WARNING

Safety precautions must be observed when installing the whip antennas on the outside of the shelter. Death can occur if an antenna comes in contact with electrical power lines. Prior to installation of the whip antennas, survey the area carefully for location of power lines, their height above ground level, and their proximity to the installation site. The antenna must be installed as far

away as possible from electrical power lines, and never closer than twice the height of the antenna.

- a. Check to see that the antenna bracket assemblies and mast bases have been installed on the shelter (fig. 1-2 and 1-3). Install the transmitting and receiving whip antennas as instructed in b through d below.
- b. Select the following items from the storage cabinet:

Quantity	Item
7	Mast Section MS-116-A
3	Mast Section MS-118-A
3	Mast Section MS-117-A
2	Receiving whip antenna insulated guy assembly
1	Transmitting whip antenna insulated guy assembly

- c. Assemble a receiving antenna as follows:
 - (1) Screw one Mast Section MS-116-A into another MS-116-A. Be sure that the connection is tight.
 - (2) Screw one Mast Section MS-117-A into one Mast Section MS-118-A. Be sure that the connection is tight.
 - (3) Screw the MS-116-A into the MS-117-A. One receiving antenna will consist of two MS-116-A's, one MS-117-A, and one MS-118-A.
 - (4) Screw the MS-116-A into Mast Base MP-65-B mounted on the exterior front wall.
 - (5) Assemble another receiving antenna as described in (1) through (3) above. Screw the completed antenna into the other Mast Base MP-65-B on the exterior front wall.
 - (6) If the radio set is to be operated while in motion, attach the whip antenna holddown guys for the receiving antennas at the junction of the third and fourth mast sections. Pull the antenna down to a forward horizontal position. Secure the other ends of the whip antenna holddown guys to the headlight grille or front bumper of the truck.
- d. Assemble the transmitting antenna as follows:
 - (1) Screw three Mast Sections MS-116-A together, and tighten the connections.
 - (2) Screw one Mast Section MS-117-A into a Mast Section MS-118-A, and tighten the connection.
 - (3) Screw the two assembled mast sections together. One transmitting antenna will consist of three MS-116-A's and one each MS-117-A and MS-118-A.
 - (4) Screw the assembled mast sections into Mast Base MP-76.

(5) If the radio set is to be operated while in motion, bend the antenna backward to a horizontal position and attach the whip antenna holddown guy rope to the top of the highest MS-116-A. Attach the other end of the guy to the power unit trailer.

2-6. Installation of Doublet Antennas and Mast AB-155(*)/U

a. General. The doublet antenna equipment furnished with Radio Set AN/GRC-26D may be used instead of the whip antennas when operating from a fixed or semifixed location to provide greater directivity or signal pickup. When the AN/GRC-26D is operated within the frequency range of 1.5 to 4.0 MHz, the length of the antenna wire requires the use of three 40-foot Masts AB-155(*)/U for each antenna. At frequencies above 4.0 MHz, only two masts are required for each antenna. Each antenna should be positioned broadside to the direction of transmission or reception. When space diversity reception is used, the receiving antenna's should be separated by at least three wavelengths at the lowest frequency.

b. Antenna Construction. The antenna is a half-wave doublet which is normally operated at the half-wave fundamental of the desired frequency. If the antenna is to operate on more than one frequency, the radiating portion may be of a number of predetermined lengths of Wire W-1 separated by strain insulators and interconnected as required by jumpers. Construct the antenna as follows:

(1) List the operating frequencies.

(2) Refer to figure 2-2, and determine the overall antenna length for the fundamental frequency of each frequency assigned.

(3) Divide each overall antenna length ((2) above) by 2. This gives the antenna length, including strain insulators, of each side measuring from the coaxial connector.

(4) Attach one end of the antenna wire to the coaxial connector (B, fig. 2-1); use a splice conductor and the wingnut on the coaxial connector. Run out the required length of Wire W-1 for the highest fundamental frequency to be used ((3) above), and connect it to the strain insulator. Construct the other half of the antenna in exactly the same manner.

(5) Attach the antenna wire for the next lower frequency to the unused end of the strain insulator of the antenna already constructed ((4) above). Allow enough wire for a jumper connection. Run out enough Wire W-1 to obtain the total length required (difference between

highest frequency length and length required) for this frequency ((3) above) as measured from the center of the coaxial connector to the end of the section being constructed. Connect the free end to a strain insulator. Construct the other half of the antenna in exactly the same manner.

(6) Construct each additional lower frequency antenna by adding more Wire W-1 to the antenna already formed. Each antenna length should be measured from the center of the coaxial connector to the end of the antenna being constructed, including the length of the strain insulators.

(7) After the antenna is constructed, use the splice conductors to connect the required jumpers in place (A, fig. 2-1) for the primary operating frequency. Each antenna constructed will operate on the fundamental and odd harmonics of the fundamental frequency for which it is constructed. C, figure 2-1 shows an assembled antenna for 2,600, 2,750, 3,100, and 3,900 kilohertz (kHz). Figure 2-2 shows that a fundamental antenna for 2,600 kHz may also be used for 8,300, 13,800, or 19,300 kHz.

c. Mast AB-155()/U Erection.* After the antenna has been constructed, determine the position for the antenna to be erected. A compass is required for accurate determination of antenna orientation. Stretch the assembled antenna along the ground in the desired position. Place the antenna in a position to allow proper connection of the antenna to the equipment in the shelter after it is raised. Plan to erect the end masts several feet beyond the end insulators. The center mast should be at the coaxial connector and offset 3 feet from the line of the antenna (fig. 2-5). A center mast will not be required if the overall antenna is less than 120 feet long. Erect each Mast AB-155(*)/U as follows:

(1) Place Mast AB-155(*)/U at each mast location and remove Cover CW-124/GRA-4 from Carrying Device MX387/GRA-4 (fig. 1-17).

(2) Drive the stake of Mast Base AB-154/ U into the ground at the desired mast location with the swivel end pointing 45° from the line of the antenna (fig. 23). If the ground is soft or sandy, place the mast base plate (fig. 25) on the ground and push it down firmly; then drive the stake of Mast Base AB-154/U through the hole in the mast base plate.

(3) Align the female ends of Mast Sections MS-44-(*) toward the mast base. Connect the first mast section (fig. 23) to Mast Base AB1154/U; add the second and third mast sections. Place a Guy Plate MX378/U over the third

section. Add the fourth and fifth sections; place a second MX478/U over the fifth section. Add three more mast sections, and place a third MX378/U over the last section.

(4) Slip a Guy Fastener MX-379/U over each guy stake before it is driven into the ground. Drive a guy stake (back guy stake) into the ground at the junction of the fifth and sixth MS44-(*) (25 feet from Mast Base AB-154/U). Place the front and side guy stakes 90° apart as shown in figure 2-3. Use a guy rope to measure the distance between the mast base and the front and side guy stakes. If the ground is soft or sandy, use the wooden stakes instead of the aluminum stakes, and loop the guys over the stakes.

Do not use the MX379/U's.

(5) Fasten four Guys MX-383(*)/GRA4 to top Guy Plate MX-378/U, four Guys MX381(*)/GRA-4 to center Guy Plate MX-378/U, and the remaining four Guys MX-382(*)/GRA4 to bottom Guy Plate MX-378/U. Fasten the guys by snapping the fastener at the end of each guy into one of the four holes located 900 apart on the MX-378/U. Next, carry the free ends of the three back guys to a side guy stake to measure their correct length, Fasten these guys to the back guy stake with Guy Fastener MX379/U. Connect both sets of side guys to their respective side guy stakes, and remove slack by adjusting Slide Fastener FT-9 (fig. 2-3). Do not overtighten because the mast may bend. Keep the three front guys together, and stretch them along the mast toward the front guy stake.

(6) Remove Halyard MX-516(*)/GRA-4 from the carrying device, and attach the snap fastener on the pulley to the unused hole in the top Guy Plate MX378/U. Slip the rope through the pulley (fig. 2-5), and tie the ends of the rope near the mast base to keep the rope from running through the pulley when raising the mast.

(7) To raise the mast (fig. 2-4), three men are required. Man No. 1 holds the front guys and pulls steadily on them, keeping slightly more tension on the top guy to bow the mast slightly while being raised. Man No. 2 takes a position near the mast base and holds Mast Base AB154/U in the designated position as the mast is raised. Man No. 3 stands near the top end of the mast and raises it as he walks toward the mast base.

(8) Adjust the guys until the mast is vertical. Whenever a guy is tightened, the opposite one may have to be loosened slightly to keep the mast from bowing.

d. Antenna Raising.

(1) If the center mast is used, attach the fastener on Halyard MX-516(*)/GRA-4 to the coaxial connector as shown in B, figure 2-1.

(2) Fasten Halyard MX-516(*)/GRA-4 on each end mast to the antenna wire by attaching one end of a wire (approximately 15 inches of Wire W-1) to the end strain insulator, and the other end to the fastener assembly on Halyard MX-516(*)/GRA-4.

(3) Pull the antenna wire into position with Halyards MX-516(*)/GRA-4. Tie the rope to the mast to prevent the weight of the antenna wire from pulling the loose end of the rope back through the pulley. Figure 2-5 shows a doublet antenna completely erected.

e. Antenna Connection. The antenna lead-in should be raised off the ground on poles if possible. In cold weather, raising the lead-in prevents the antenna lead-in from freezing to the ground and, at all times, minimizes damage which might result from lying on the ground. In addition, the antenna lead-in should be taped to both the mast and the shelter to relieve the tension on the coaxial connector.

(1) *Transmitting.* Disconnect Cable Assembly, Radio Frequency CG-1333/U from the OUTPUT receptacle on the matching unit and the terminal posts on the tuning unit. Pass the antenna lead-in through the feedthrough in the rear wall of the shelter, and connect it to the OUTPUT receptacle on the matching unit; use Radio Frequency Adapter UG-27C for coupling.

(2) *Receiving.* Disconnect Radio Frequency Cable Assemblies CG-718A/U (8 ft) from the UNBALANCED receptacles on the receivers. Disconnect Radio Frequency Cable Assembly CG718A/U (24 ft) from the BALANCED receptacle on the receiver. Pass the antenna lead-ins through the feedthrough in the forward wall of the shelter, and connect them to the BALANCED receptacles on the receivers. Use Adapter Connectors UG-97'1/U as couplings.

f. Other Antenna Installation. If there is not enough time to erect the masts, construct a semifixed installation by using materials other than those supplied as a support for the antenna wire.

Antenna supports can be improvised by using poles, trees, buildings, or other suitable supports whenever possible. The doublet antenna must always be insulated from its supports.

g. Erection of Doublet Antenna Using Tripod Adaptor Mast AB-1089/U. The tripod mast adaptor (fig. 2-10) was designed to provide a stable antenna mast which can be erected quick

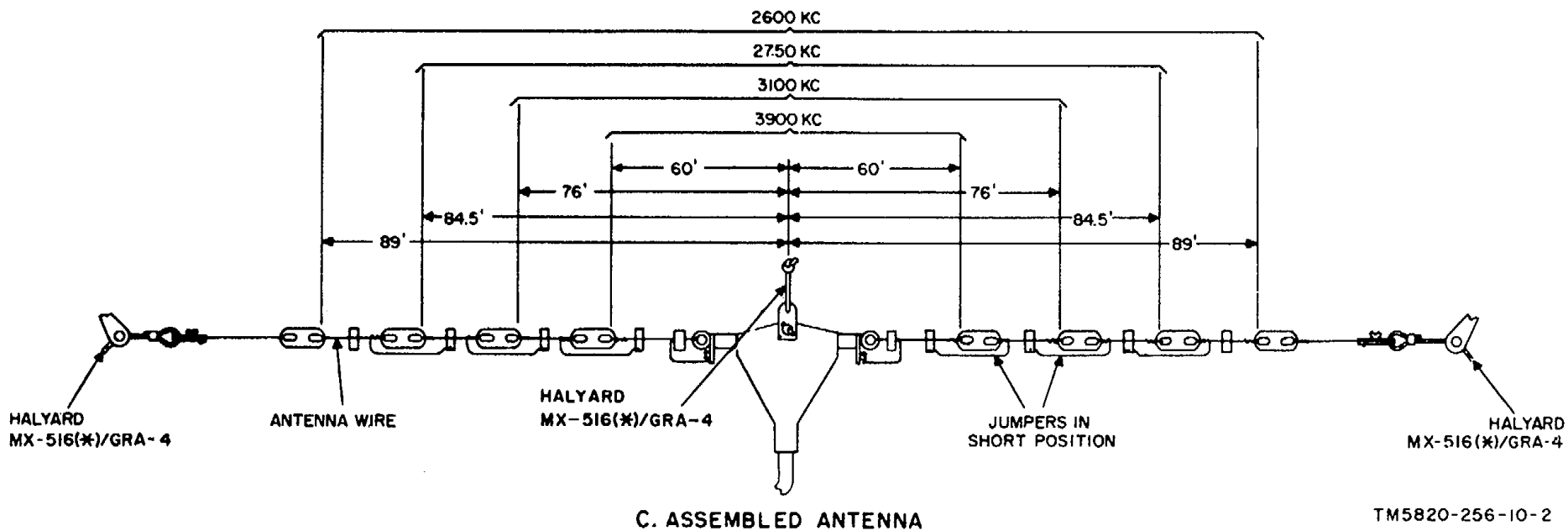
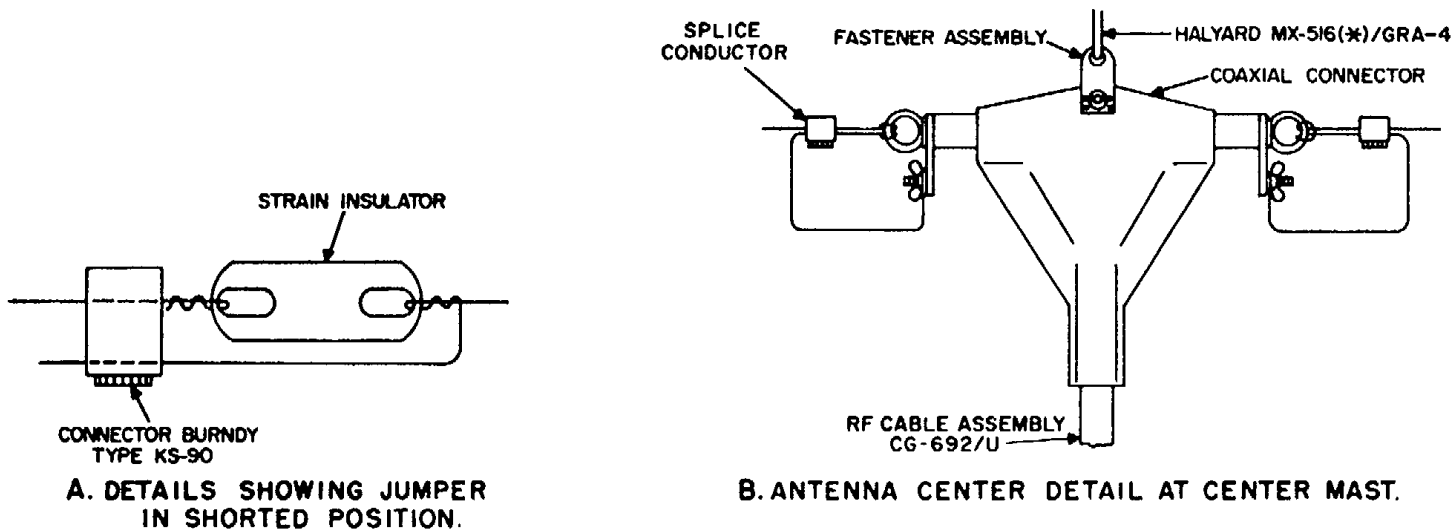

TM5820-256-10-2

Figure 2-1. Construction and assembly of doublet antenna.

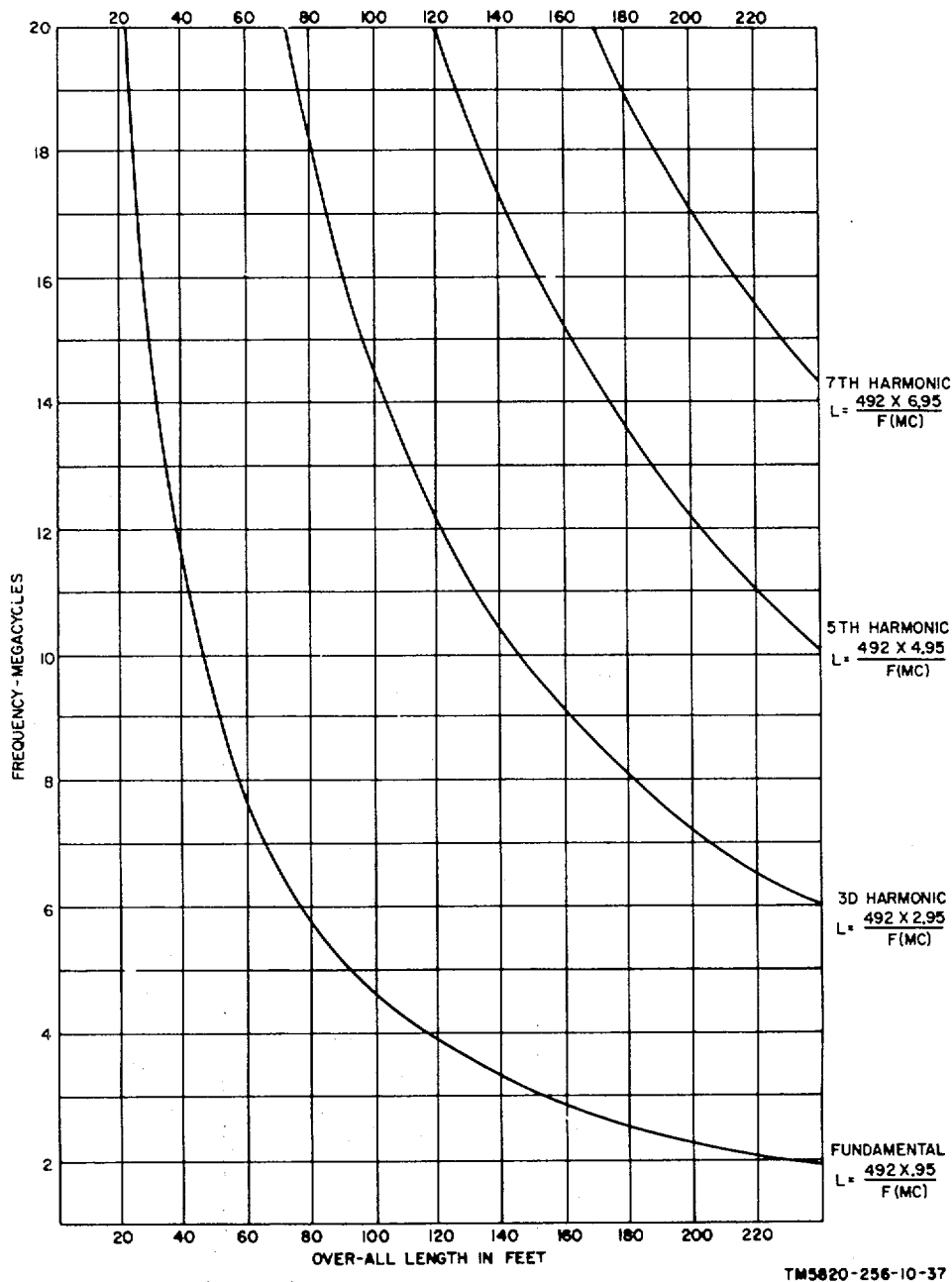

Figure 2-2. Graph of antenna length versus frequency.

ly. The assembled mast (fig. 2-11) is inherently stable. A doublet antenna erected on level ground with three such masts can withstand winds of approximately 25 miles per-hour without the use of guy lines. Parts of Mast, AB-155(*)/U furnished with Radio Set AN/GRC-.26D are used for the tripod mast. To obtain full mast height, one additional Mast Section, MS-44 for each Mast, AB-155(*)/U is required. To erect a doublet antenna using three tripod masts proceed as follows:

(1) Join six Mast Sections MS-44 into three two-section lengths.

(2) Insert a two-section length into each of the adaptor legs.

(3) Join three mast sections together inserting a guy plate between the upper two sections and insert the lower end of this assembly into the hole in the upper deck of the mast adapter (fig. 2-11).

(4) Place a standard guy plate over the top mast section.

(5) Attach a pulley and halyard to the top guy plate. Attach three guy lines to the lower guy plate.

(6) Repeat the above until three tripod masts are completed.

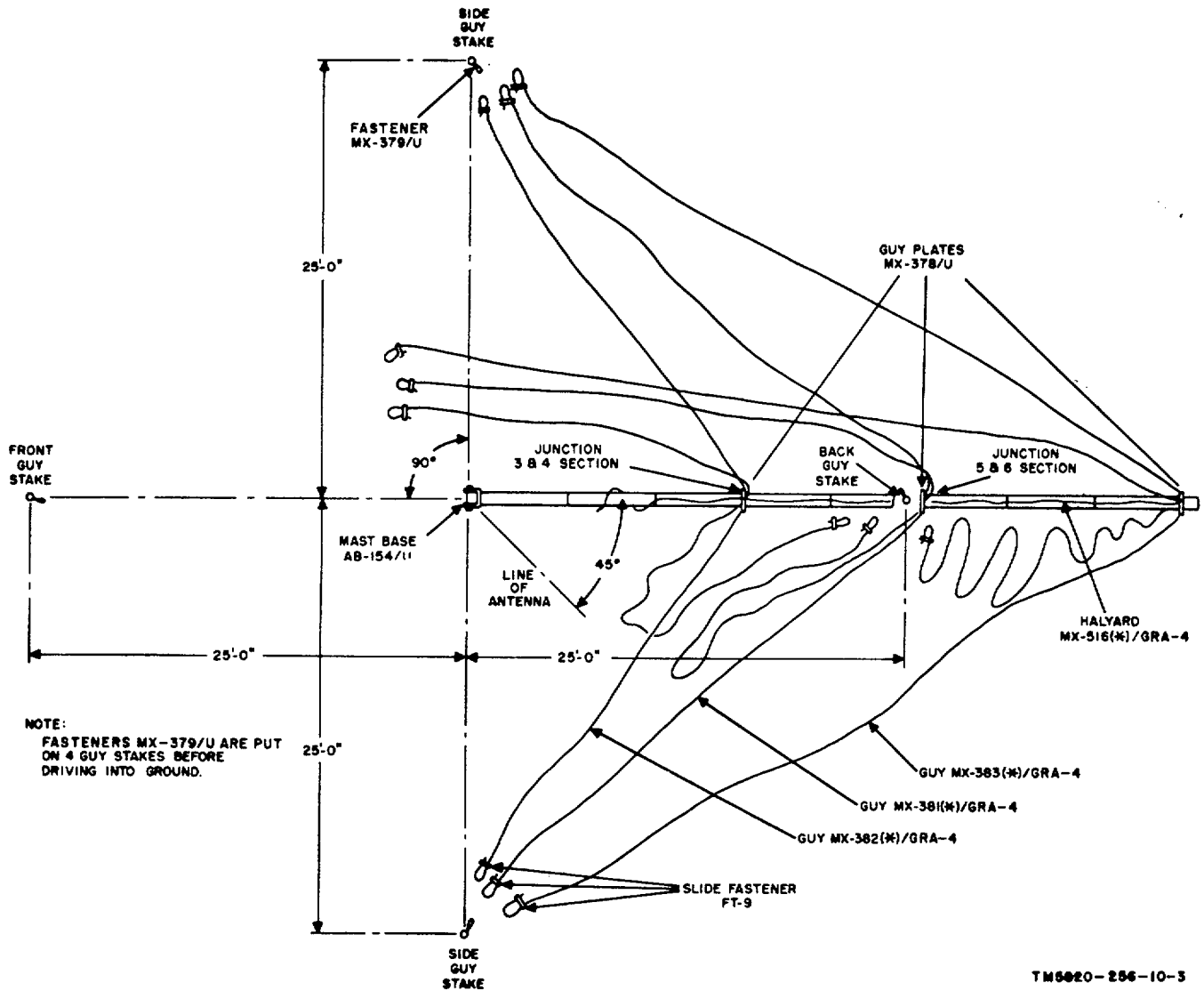

Figure 2-3. Preparing Mast AB-155(*)U for erector

- (7) Prepare the antenna as shown in figure 2-1.
- (8) Drive three guy stakes and orient the tripod legs as shown in figure 2-12. Six remaining guy stakes can be driven when time permits.
- (9) Connect the halyard of the center mast to the fastener assembly as shown at B of figure 2-1 and hoist to full elevation. Allow the three guy lines connected to the lower guy plate to hang free.
- (10) Secure center guy lines to center guy stakes.
- (11) Connect the halyards of the end masts to the ends of the doublet.
- (12) Hoist both end masts simultaneously and tie into guy stakes. Allow the three guy lines attached to the lower guy plate of each mast to hang free.

(13) Complete antenna connections as described in paragraph e above. The antenna installation as described above is inherently stable. Stability should be enhanced, however, as soon as convenient by driving the additional guy stakes shown in figure 2-12 and connecting the guy lines as indicated.

2-7. Installation of Fuses and Batteries

a. Shelter.

- (1) The operating equipment is installed within the shelter. Check to see that all operating equipment is firmly in place.
- (2) Make sure that the correct fuses are installed in the equipment. The equipment may fail if fuses other than those specified are used. The chart below lists the fuses used in each component.

<i>Equipment</i>	<i>Fuse</i>	<i>Rating (amperes)</i>	<i>Location</i>
Transmitter, Radio T-368 (')/URT-----	F1	6	Front panel of power supply deck.
	F2	3	
Modulator, Radio MD-239(*)/GR-----	F1	1 1/2	Front panel.
	F2	1 1/2	
Teletypewriter TT-98(*)/FG-----	F1	2	Behind right cover door.
	F2	1/4	Below door above power supply.
	F4	1/16	Behind left cover door.
Reperforator-Transmitter, Teletype- writer TT-76/GGC	F1	1.6	Under dust cover.
or			
Reperforator-Transmitter, Teletype- writer TT-76A/GGC	F1	1.6	Under dust cover.
	F2	1.6	
or			
Reperforator-Transmitter, Teletype- writer TT-76B/GGC	F1	2	Under dust cover.
	F2	2	

(3) Telephone Set TA-43/PT or Telephone Set TA-312/PT requires two Batteries PA-30 (not supplied with the radio set). For battery installation instructions, refer to the technical manual for the particular equipment (app A).

b. Power Unit. Examine the storage battery in the power unit, Instructions for preparing the battery for service are attached to each battery. Follow instructions carefully.

2-8. Installation of Operator Chairs

Centrally locate the two operator chairs in front of the three teletypewriter tables (A and B, fig. 2-6). Use two web straps for each chair, and strap the chairs in position; use the three floor anchors as tie points (C and D, fig. 2-6).

2-9. Connections

a. *Primary Power.* The shelter contains permanently wired power outlets that provide ac power to the components of the radio set. When Switch Box SA-331/U is supplied with the power unit, connect 12-foot 6-inch Power Cable Assembly CX-6485/U between the ac power receptacle at the rear of the shelter and the OUTPUT receptacle of the SA-331/U. Two Power Cable Assemblies CX-2254/U are connected from the INPUT receptacles of the SA-331/U to the ac outlet terminals on the power unit. The SA-331/ U GND terminal is connected to the frame of the grounding system in the trailer. If the power unit is operated more than 12 feet from the shelter, insert extension Power Cable Assembly CX-1166/U between the CX-6485/U and the shelter. When Junction Box J-85/G is used with

the power unit instead of the SA-331/U, connect Power Cable Assembly CX-1165/U between the J-85/G and the shelter. When the power unit must be more than 12 feet from the shelter, insert an extension Power Cable Assembly CX1166/U between the CX-1165/U and the shelter.

Connect the cords from the J-85/G to the power unit.

b. *Grounding.*

(1) A grounding system (fig. 2-7) is permanently installed along the shelter walls and is an integral part of the shelter. The tuning unit, fsk-modulator, and transmitter are grounded with a ground strap from the ground bus to a mounting stud on the top of the transmitter. Ground straps also connect the right side panel of the storage cabinet and the equipment cabinet. A ground strap connects the matching unit to the ground bus. At the left of the transmitter, a ground strap assembly is attached to the primary power conduit, which places the housings of all ac outlets at ground potential.

(2) The reperforator is grounded through the ac power cord shield to the ac outlet housing. The spade lug, terminating the shield, is attached to the existing retaining screw on the ac outlet. The ac power cord shield of each page printer is attached directly to the ground bus (fig. 2-7). Teletypewriter tables are automatically placed at ground potential when they are secured to the shelter wall (and ground bus) with the rotolock fasteners.

(3) Place the shelter grounding system at earth potential by using the ground rod and the electrical lead. Drive the ground rod into the earth. Clamp one end of the electrical lead to the

ground rod, attach the ground rod, and attach the free end of the lead to the shelter external ground connector (fig. 1-3).

(4) When the shelter must be stationed over a soil having a very low conductivity, treat the soil to reduce its resistance. The soil can also be treated with substances that are highly conductive when in solution. Some of these substances, listed in order of preference, are: sodium chloride (common salt), calcium chloride, and magnesium sulphate (Epsom salt). The amount required depends on the type of soil and its moisture content.

c. *Interunit Cabling* (fig. 5-1 and 5-2). The AN/GRC-26D is shipped with all interunit cabling complete. Check to see that the cable connectors and plugs are securely connected prior to operating the equipment.

d. *Remote Site*. The application of teletypewriter equipment at the remote site varies because of its flexibility. A typical remote site is shown in figures 2-8 and 2-9.

(1) One-way reversible and duplex operation at the remote site is possible by use of the remote control unit and telephone and teletypewriter equipment. The remote site is connected to the radio set by field wire (not supplied with the radio set). The telephone and teletypewriter equipment for the remote site is not supplied with the radio set.

(2) Connection of wire pairs between the remote site and the shelter is illustrated in TM 11-5820-256-10 figures 2-8 and 2-9. For proper operation, wire

polarity must be observed between the control unit and the remote control unit. It is not necessary to observe wire polarity between the telephone and the remote control unit.

(3) Bring the wires into the shelter through the feedthrough above the control unit, and connect them to their respective binding posts as shown in figures 2-8 and 2-9.

(4) Remote operation is generally intended for distances up to 10 miles. Greater distances will result in increased losses that cannot be compensated. All normal remote operation may be accomplished -then the remote site is cabled to components in the shelter as shown in figures 2-8 and 2-9 and the remaining shelter components are cabled as shown in figures 5-1 and 5-2.

2-10. Initial Adjustments

a. Certain installation and preoperational checks and adjustments must be made to the power unit, converter, page printers, and reperforator during installation of the AN GRC-26D. Refer to the applicable technical manual listed in appendix A for a description of these checks and adjustments.

b. Adjustments to the receivers and transmitter normally are performed only during a change in operating frequency.

c. The fsk-modulator, remote control unit, and control unit do not require any initial adjustments.

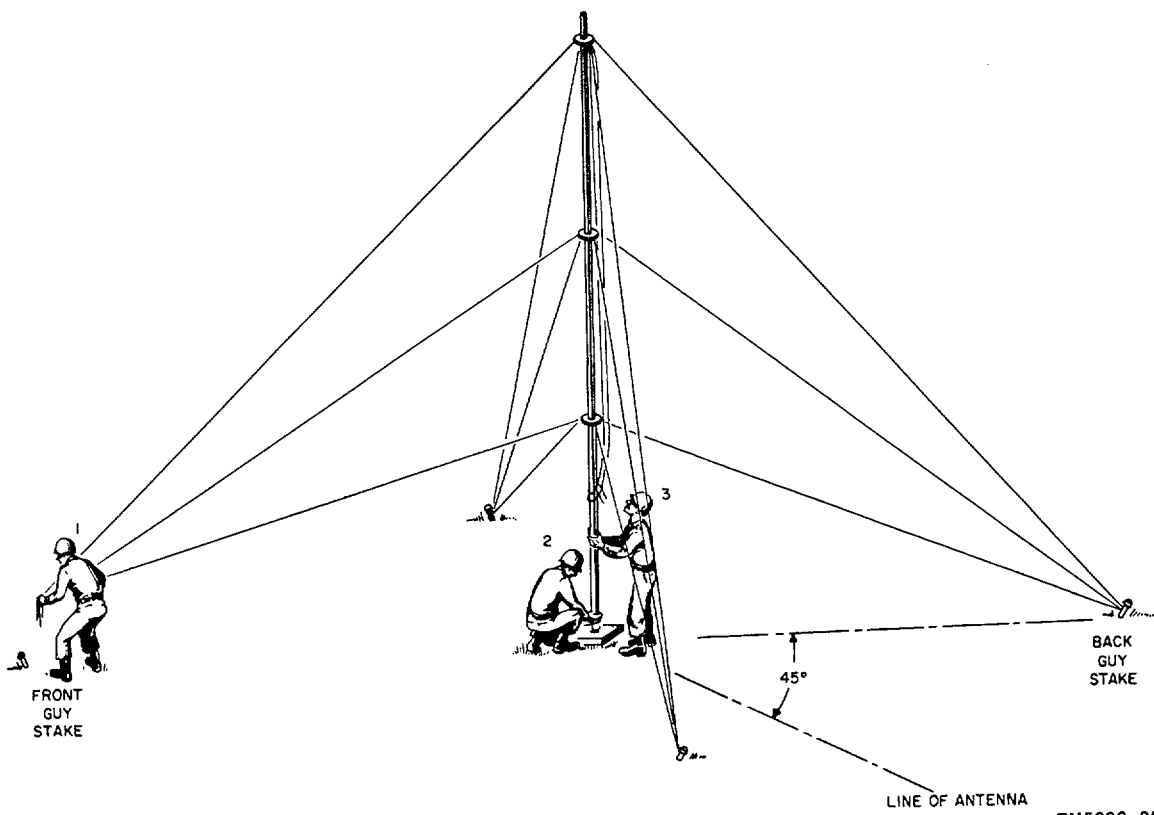
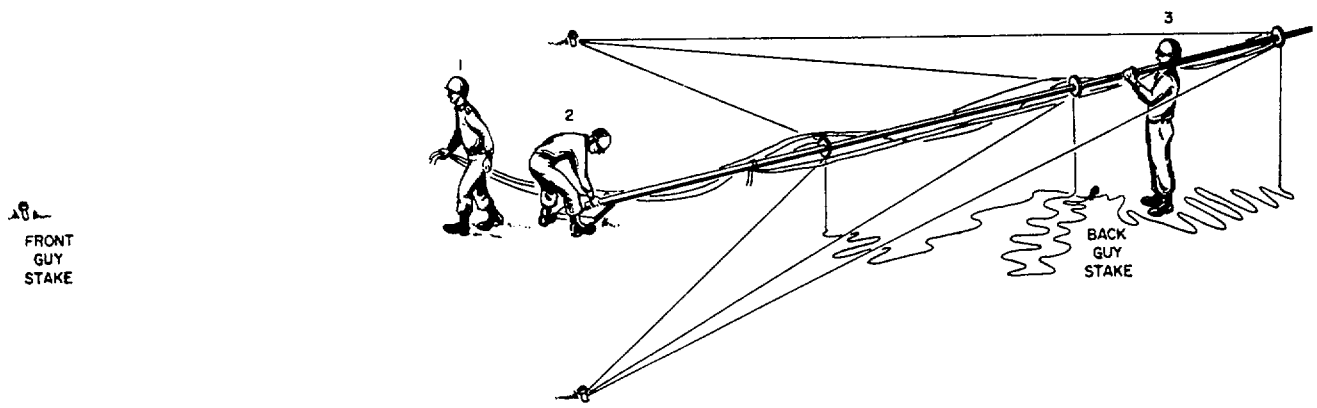

TM5820-256-10-38

Figure 2-4. Revising assembled Mast AB -155(*)/U.

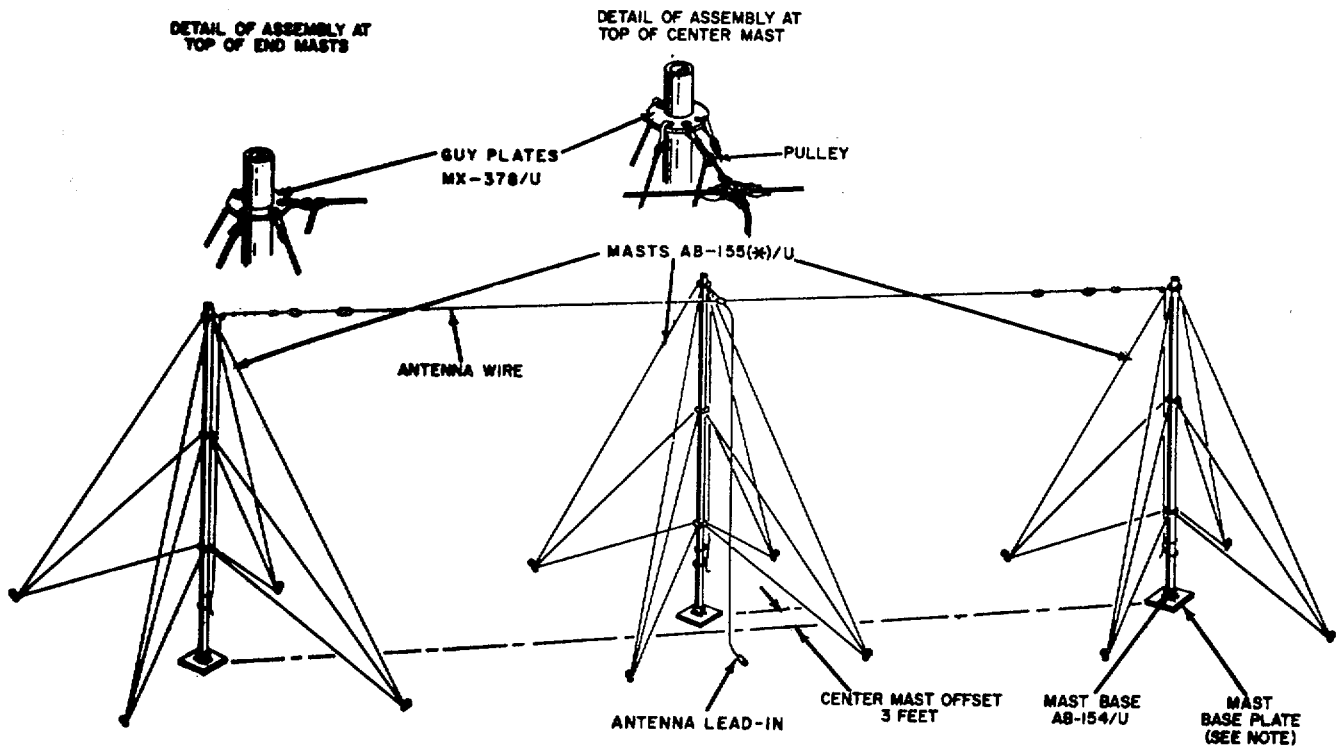

NOTE:
 THE MAST BASE PLATE IS
 USED ONLY WHEN GROUND
 IS SOFT OR SANDY.

TM 11-5820-256-10-4

Figure 2-5. Doublet antenna, erection completed

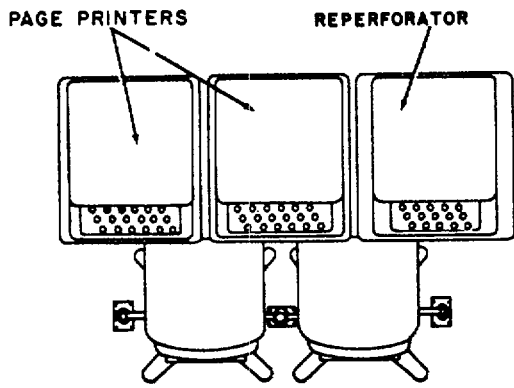

A

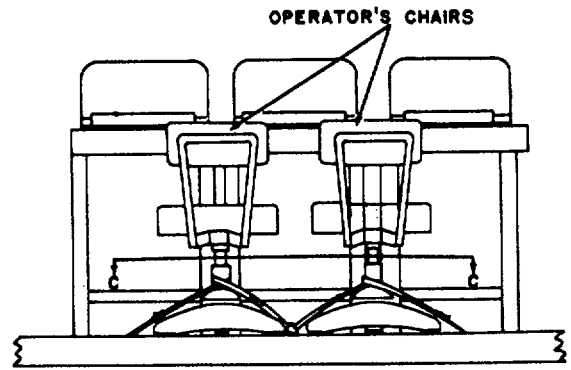

B

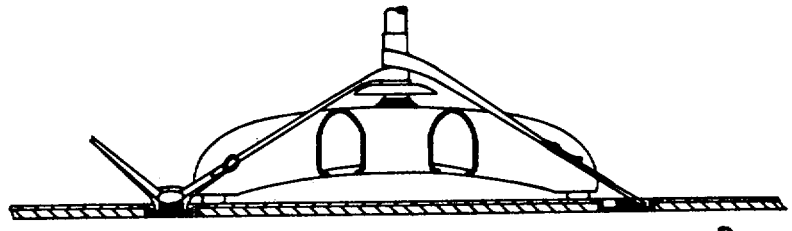
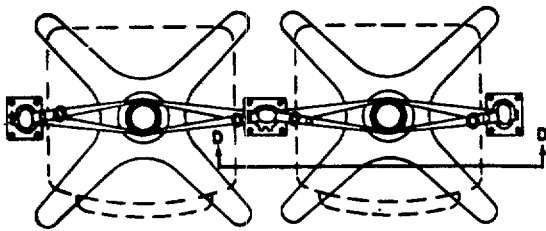

TM5820-256-10-40

Figure 2-6. Installation of operator chairs.

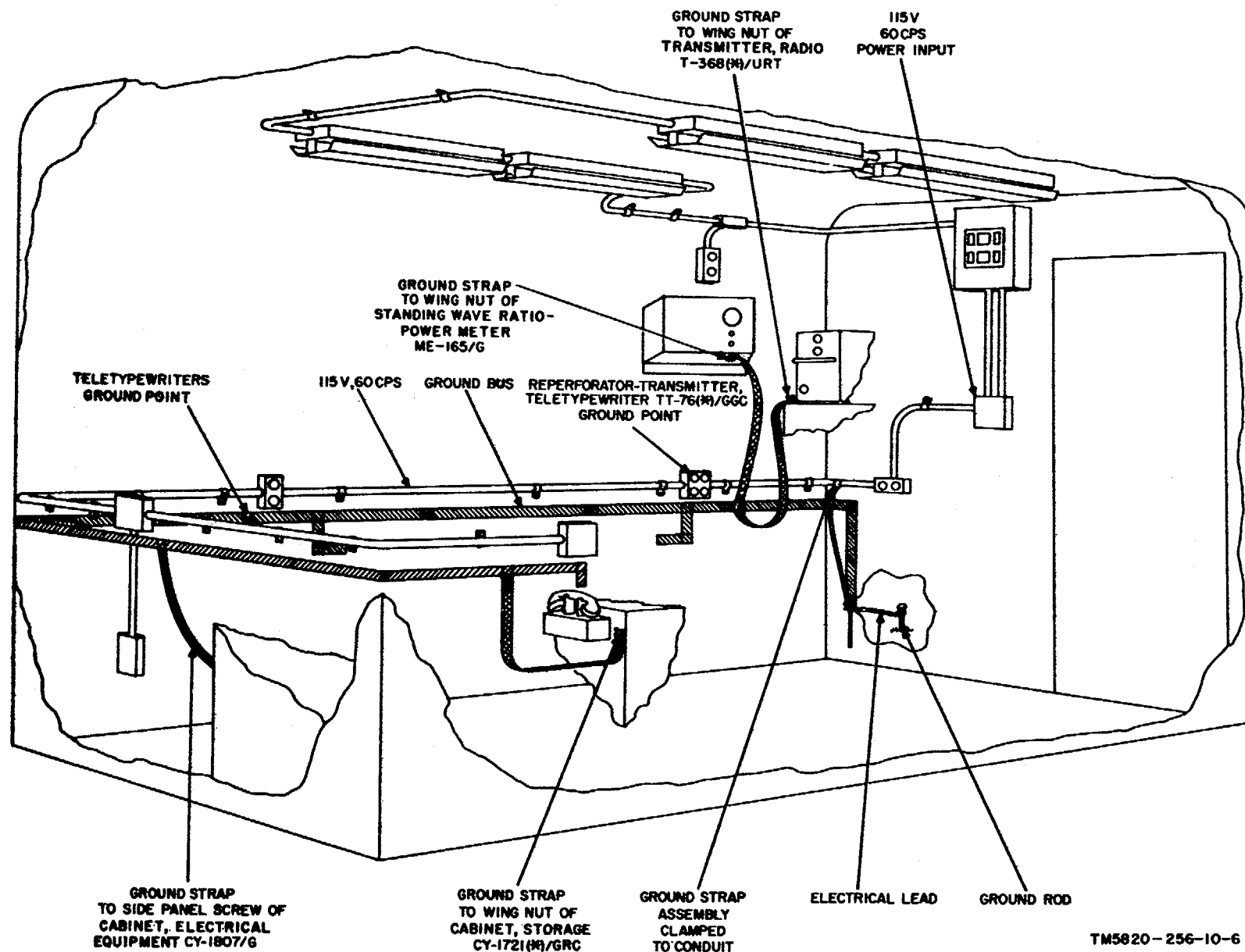
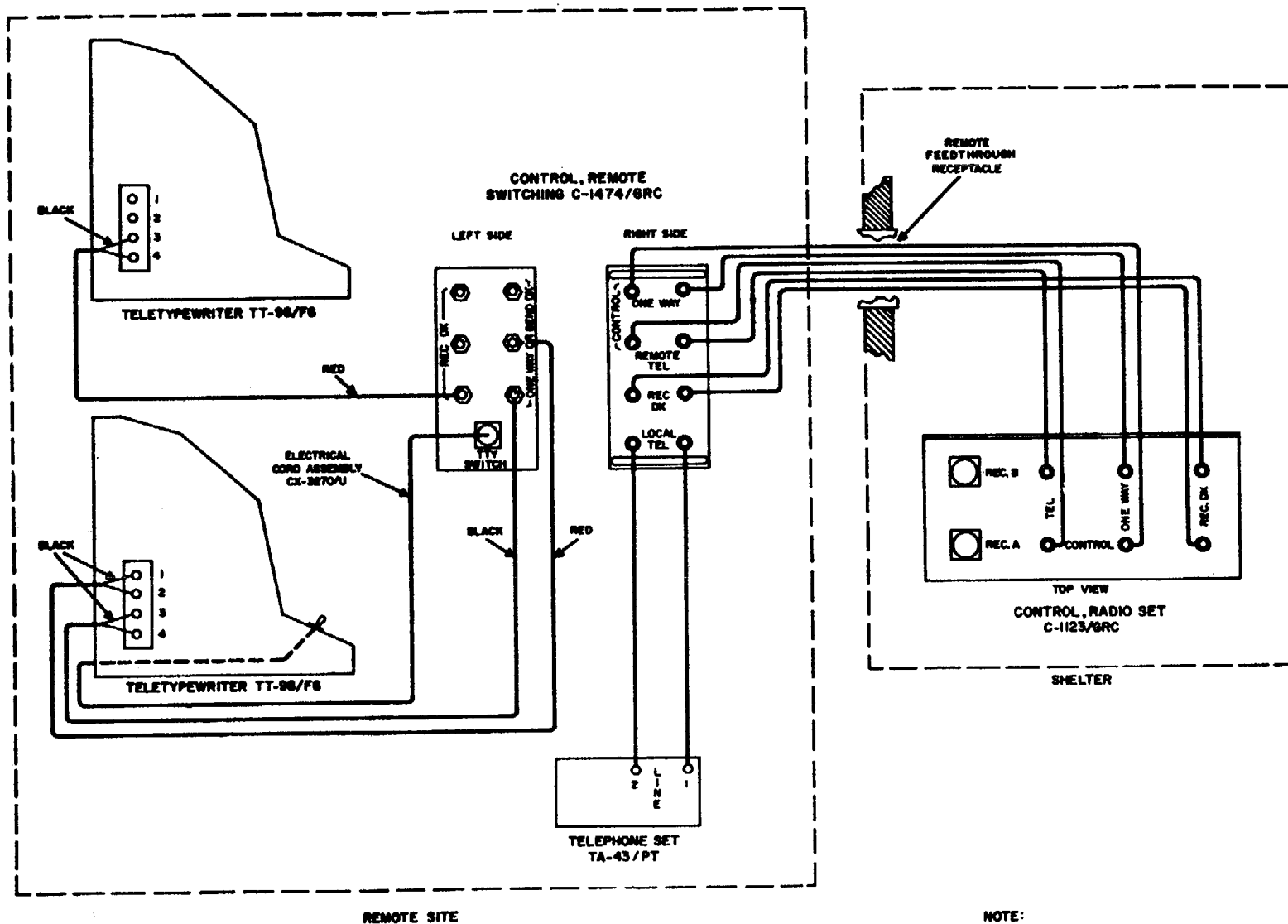

Figure 2-7. Shelter, Electrical Equipment S-56(*)/G, primary power and grounding system
2-13



NOTE:
 CONNECTING WIRE BETWEEN THE BINDING POSTS OF CONTROL, RADIO SET C-1123/8RC, CONTROL, REMOTE SWITCHING C-1474/8RC AND TELEPHONE SET TA-43/PT IS WIRE W-1.

TM5820-256-10-39

Figure 2-8. Typical remote site intercabling diagram.

Figure 2-9. Remote site cabling diagram (modified per MWO 11-5820-256-35/1).

(Located in back of manual)

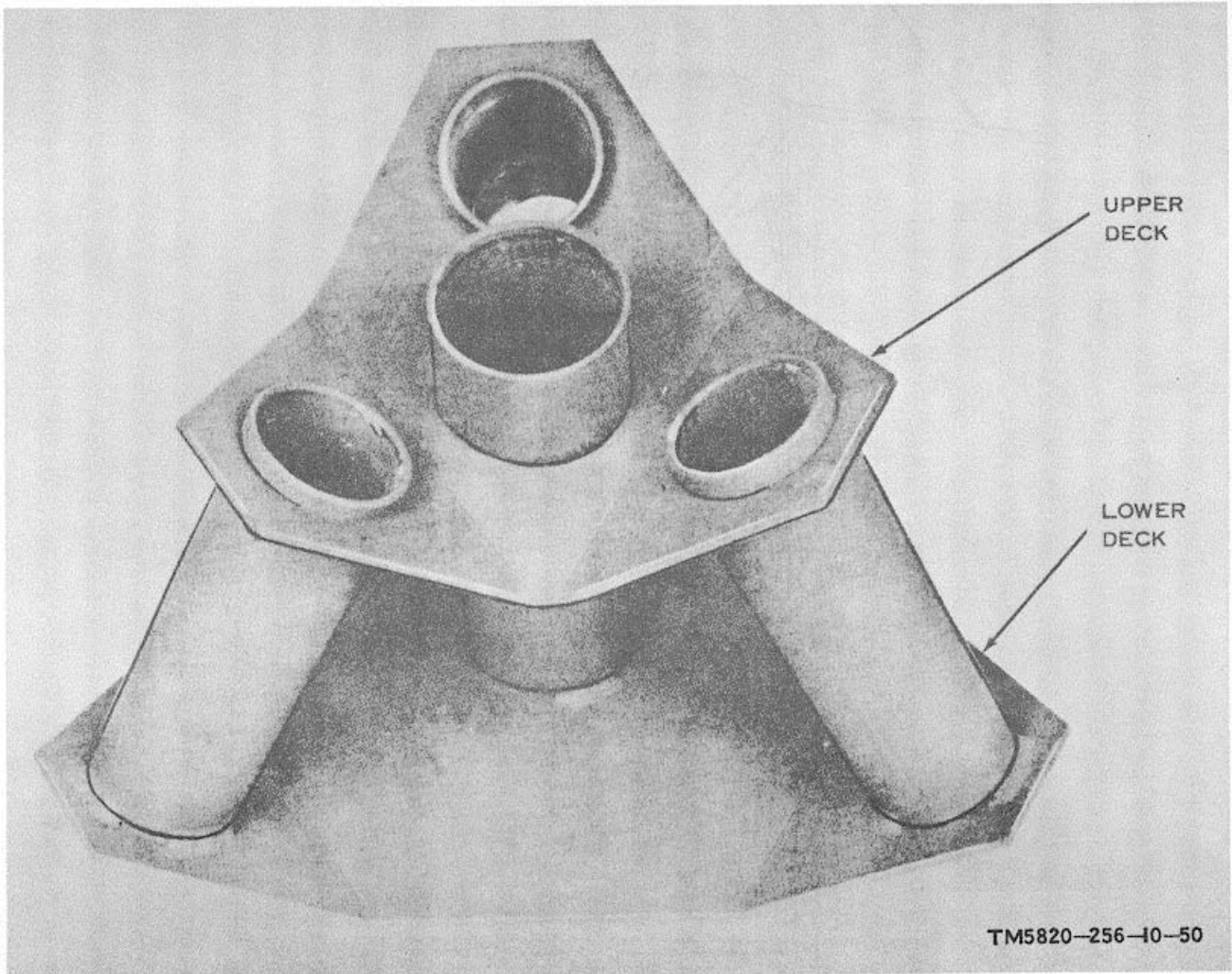

Figure 2-10. Tripod Adaptor, Mast, AB-1089/U

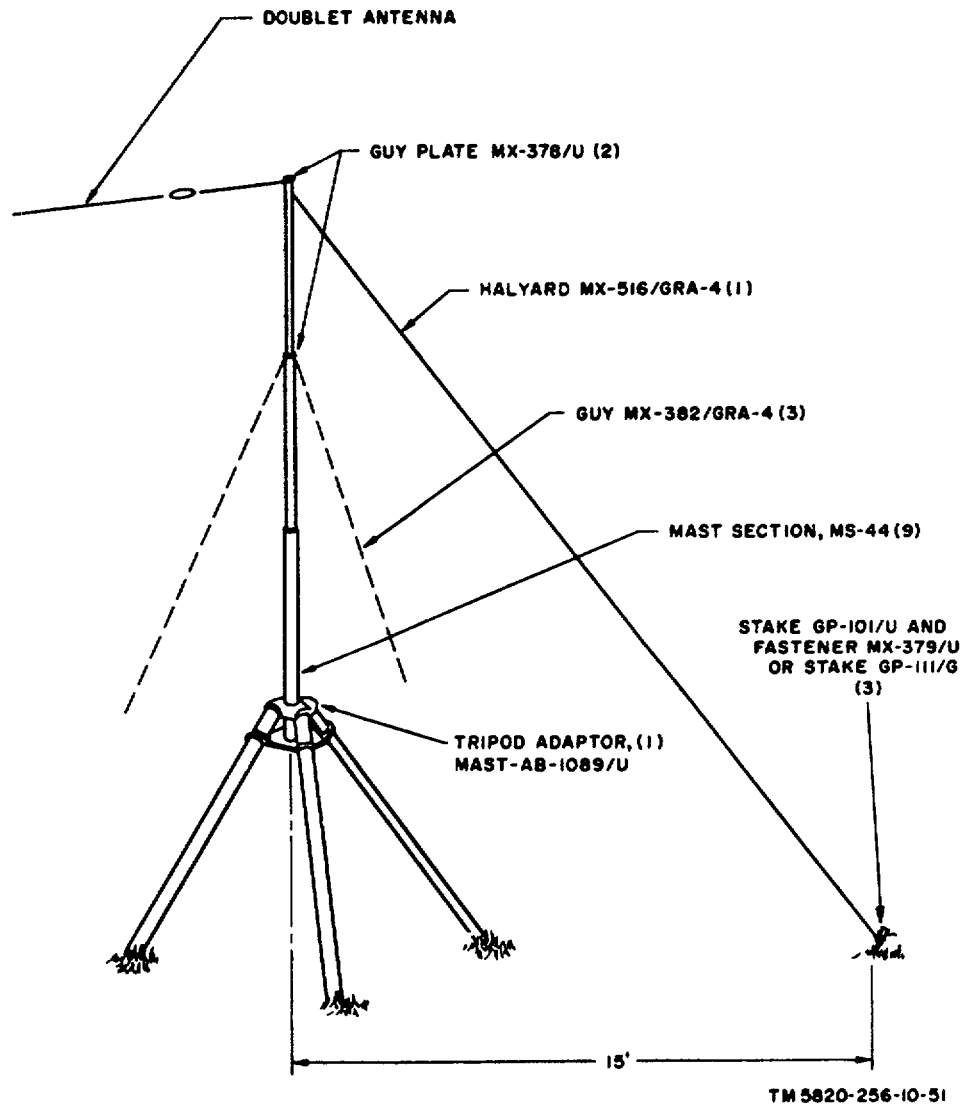
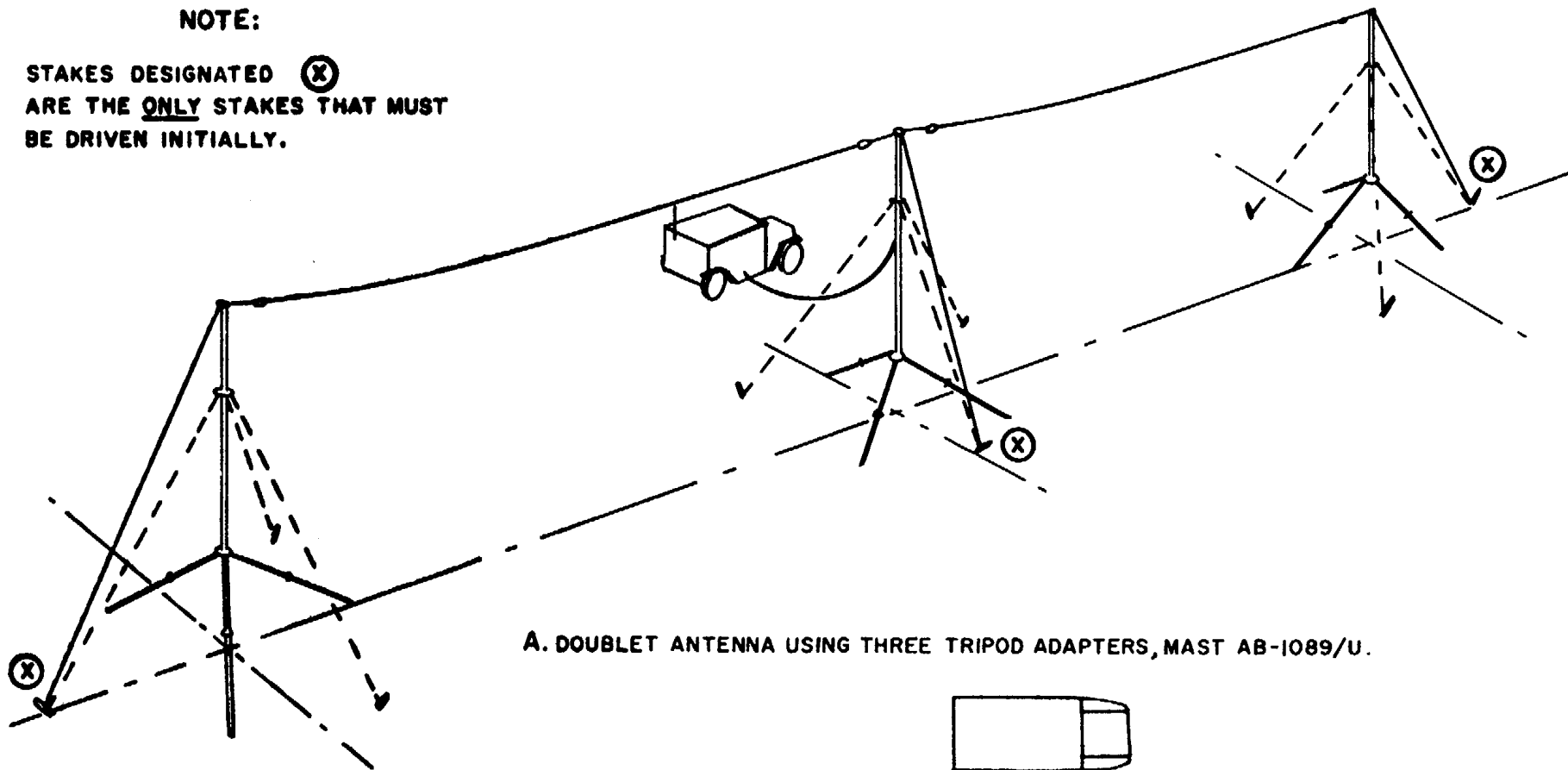

Figure 2-11. Tripod Mast, Typical Installation

NOTE:

STAKES DESIGNATED (X) ARE THE ONLY STAKES THAT MUST BE DRIVEN INITIALLY.



A. DOUBLET ANTENNA USING THREE TRIPOD ADAPTERS, MAST AB-1089/U.

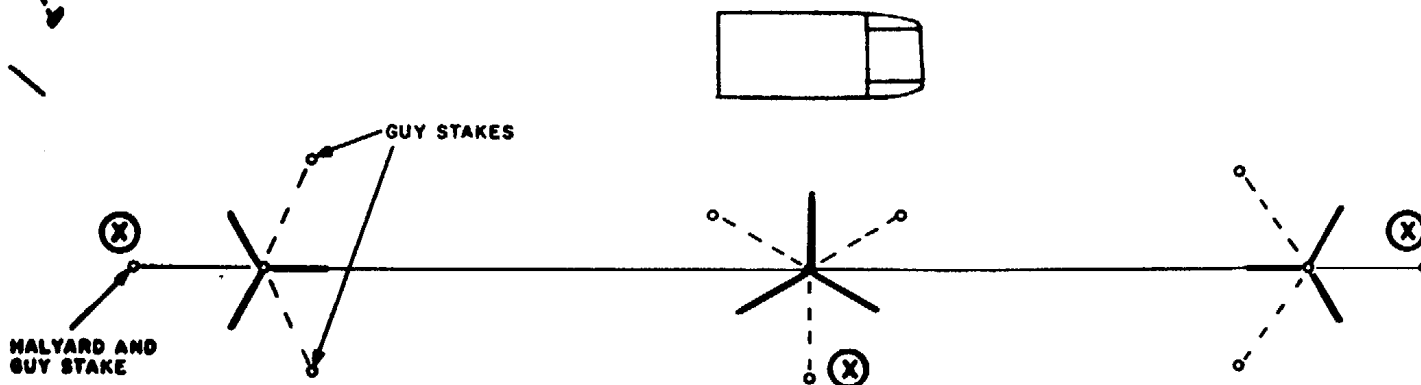

B. TRIPOD AND STAKE ORIENTATION.

EL5820-256-10-C2-TM-1

Figure 2-12. Doublet antenna installation, using Tripod Adapter, Mast AB-1069/U
Change 2 2-19

<i>Control, indicator, or Jack</i>	<i>Function</i>
REMOTE TEL switch	A three-position switch that connects the shelter and remote site telephone equipment together and to the transmitter and receiver
Sw pos	Telephone equipment connections
REC A (or RCVR A)	Connects the transmitters of the shelter and remote site telephone equipment to the transmitter. Connects the receivers of the shelter and remote site telephone equipment to receiver A.
LOCAL TEL	Connects the shelter and remote site telephone equipment together.
REC B or RCVR B	Connects the transmitters of the shelter and remote site telephone equipment to the transmitter. Connects the receivers of the shelter and remote site telephone equipment to receiver B.
HYBRID BAL control.....	Adjusts the signal level between the shelter's TA-312/PT and the transmitter.
TELETYPE switch.....	A four-position switch that connects the teletypewriter equipment for normal or remote and one-way reversible or duplex operation.
Sw pos	Type of operation
NORMAL OW	Connects the shelter's teletypewriter equipment for one-way reversible operation.
NORMAL DX	Connects the shelter's teletypewriter equipment for duplex operation.
REMOTE OW	Connects the remote teletypewriter equipment for one-way reversible operation.
REMOTE DX	Connects the remote teletypewriter equipment for duplex operation.
Pilot lamp	Indicates the presence of ac power.
REC DX jacks	Two black and four red jacks. The two black jacks are not connected. The four red jacks are connected in series and will route the received teletypewriter signals to the receive teletypewriter equipment during duplex operation.
ONE WAY OR SEND DS jacks	Two black and two red jacks. The two black jacks are connected in series and route the transmitted teletypewriter signals from the transmit teletypewriter equipment to the fsk-modulator and to the red jacks. The two red jacks are connected in series and route the transmitted teletypewriter signals to the receive teletypewriter equipment for local copy preparation. The two red jacks also route the received teletypewriter signals to the receive teletypewriter equipment during one-way reversible operation.

<i>Control, indicator, or Jack</i>	<i>Function</i>
TD jack.....	the transmit lead from the transmitter-distributor of the reperforator. Connected in series with the two black ONE WAY OR SEND DX jacks.
BIAS ADJUST control.....	Adjusts loop current to teletypewriter equipment.
Loop current meter	Indicates value of bias current.
POWER ON-OFF switch	Applies dc power to teletypewriter equipment when set to ON.
AC PWR connector	Provides for input connection of ac power cable.
DC PWR connector	Provides for output connection of dc power cable.

3-4. Minor Component Controls, Indicators, and Jacks

a. *Control, Remote Switching C- 474/GRC* (fig. 1-11 and 1-12). The remote control unit contains an external toggle switch labeled XMTR ON. When proper connections have been made between the radio set and the remote control unit, the transmitter will be keyed when the switch is set to XMTR ON. Four sets of terminals are provided for termination of remote teletypewriter equipment and marked as follows: ONE WAY OR SEND, REMOTE TEL, REC DX, and LOCAL TEL. *Control, Remote Switching C-1474/GRC*, as modified per MWO 115820-256-35/1, provides three jacks and two connectors for termination of remote teletypewriter equipment (fig. 2-9). The jacks are marked ONE WAY OR SEND DX, REC DX, and LOC TEL. The connectors are marked TTY SWITCH and REMOTE.

b. *Loudspeaker Assembly LS-206(*)/U* (fig. 1-4). The speaker assembly contains two external toggle switches labeled ON CHANNEL A and ON CHANNEL B, respectively. The ON CHANNEL A switch allows audio signals to be received from the channel A receiver when placed in the on (up) position. The ON CHANNEL B switch performs a similar function for the channel B receiver.

c. *Blower Assembly, Electrical HD-223/* (fig. 1-4). Blower Assembly, Electrical HD223/G contains an external toggle switch which controls ac power to the blowers. When the switch is set to ON, the two blowers inside the unit are activated. The pilot lamp indicates the presence of ac power.

d. *Switch Box SA-331/U* (fig. 1-18). Switch Box SA-331/U contains an external two-position 'switch labeled NO. 1 and NO. 2 and is used to switch from one Generator Set, Gasoline Engine PU-286/G to another. When the switch is set to NO. 1, power for the shelter is drawn from the PU-286/G designated No. 1. When the switch is set to NO. 2, power for the shelter is drawn from the PU-286/G designated No. 2.

e. *Junction Box J-2597/GRC* (fig. 1-8). Junction Box J-2597/GRC provides through connections when the radio set is used for the transmission and reception of clear text. During transmission and reception of encrypted traffic, the cables connected to the junction box are removed and connected to the crypto equipment and the junction box is not used.

f. *Junction Box J-2598/GRC* (fig. 1-8). Junction Box J-2598/GRC provides through connections when the radio set is used for the transmission and reception of clear text. During transmission and reception of encrypted traffic, the cables connected to the junction box are removed and connected to the crypto equipment and the junction box is not.

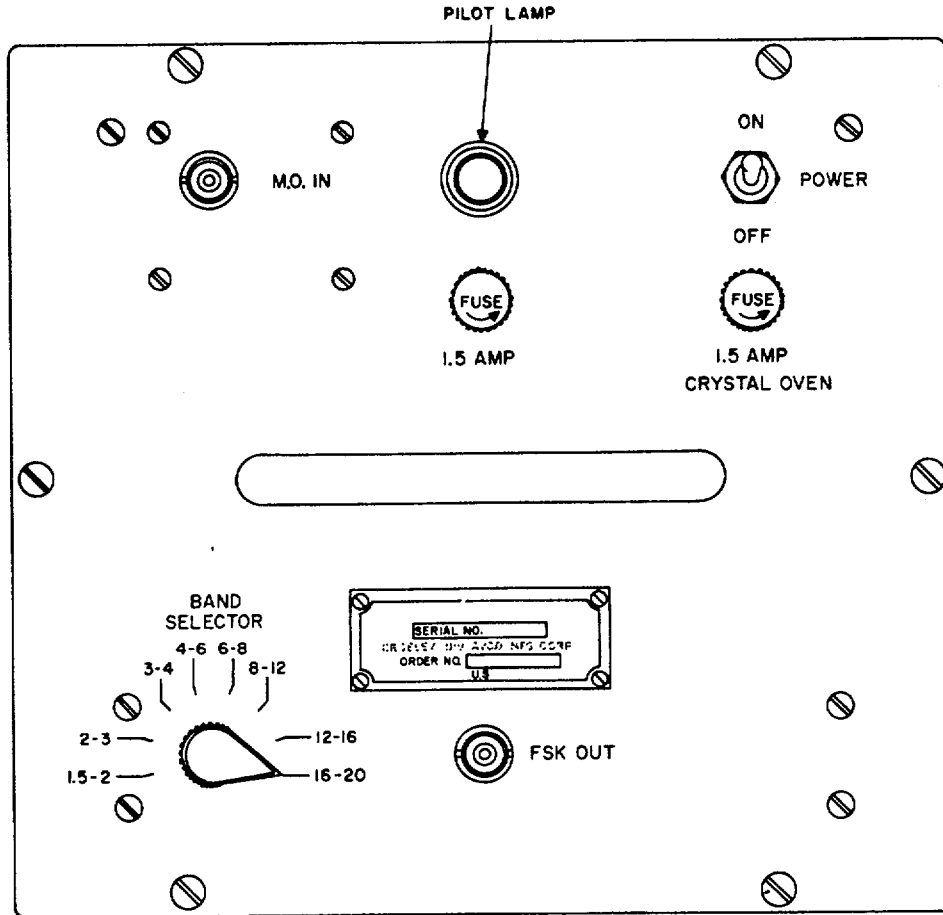

NOTE:
ON MODULATOR, RADIO MD-239/GR, THE POWER SWITCH IS LOCATED BETWEEN THE FUSES
TM5820-256-10-8

Figure 3-1. Modulator, Radio MD-239(*)/GR, front panel controls.

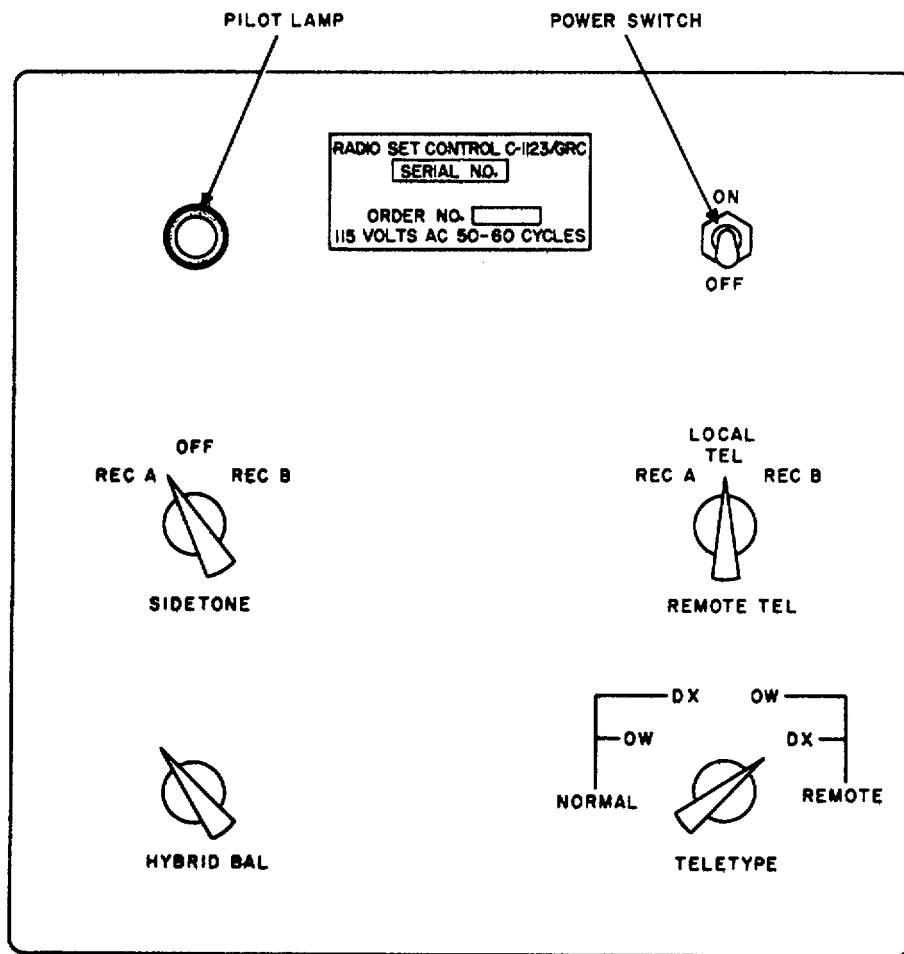

NOTE:
ON CONTROL, RADIO SET C-1123/GRC BEARING ORDER NO. 25209-PHILA-54,
PANEL MARKINGS DO NOT APPEAR AT ON-OFF SWITCH
TM5820-256-10-9

Figure 3-2. Control, Radio Set C-1123/GRC, front panel controls.

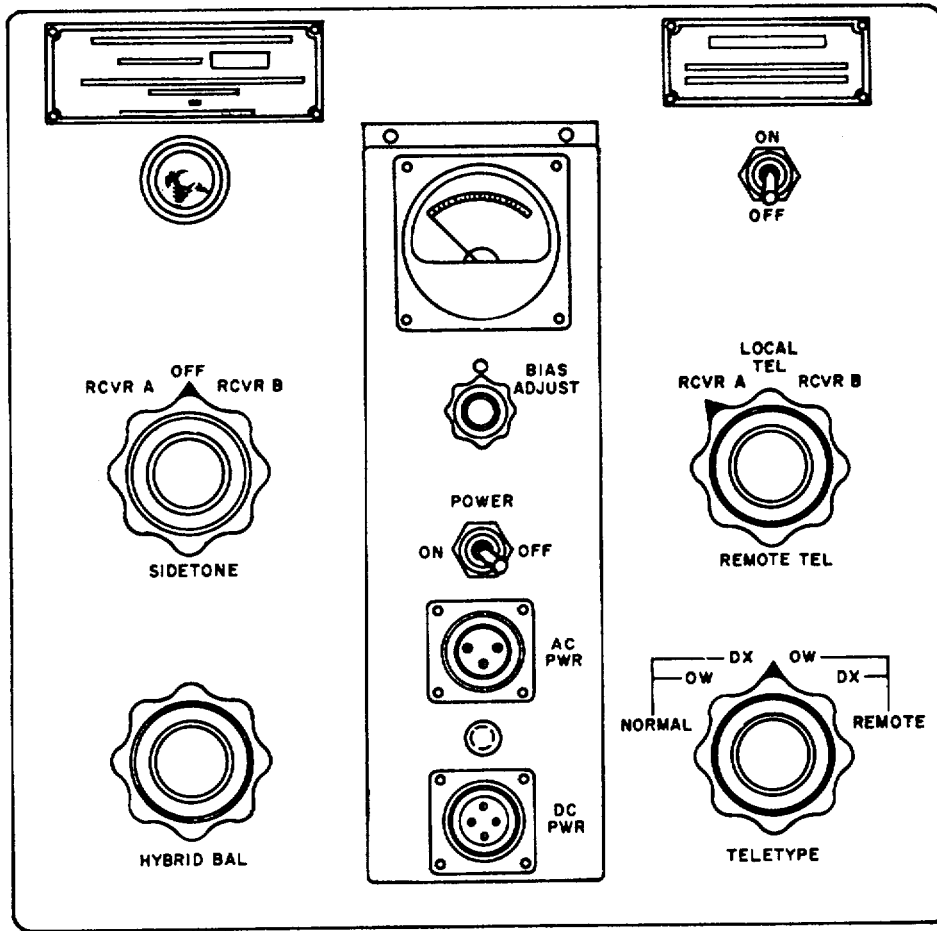

TM 5820-256-10-9 ①

Figure 3-3. Control, Radio Set C-1123/GRC (modified per MWO 11-5820-256-35/1), front panel controls.

SECTION II. OPERATION

3-5. Types of Operation

a The radio set may be operated locally (from the shelter) or from a remote site. Remote operation is possible through the use of the remote control unit. Either duplex or one-way reversible (half duplex) operation may be used. When the radio set is in motion, one-way reversible (half duplex) operation is normally used. When the radio set is at halt, either one-way reversible (half duplex) or duplex operation may be employed. Doublet antennas can be erected to provide additional operating range.

b The radio set is used primarily as a radio teletypewriter station. AM voice or cw operation is available if required.

3-6. Preliminary Starting Procedure

Preset the controls as described below before attempting to operate the equipments.

Component	Control	Position
Power unit.....	Circuit breakers	OFF
Shelter	Circuit breakers	OFF
Transmitter.....	FILAMENT POWER circuit breaker	OFF
	PLATE POWER circuit breaker	OFF
	TUNE-OPERATE switch (TUNE-NORMAL switch on some models)	TUNE
	PLATE RELAY switch ...	OFF
	KEYING CONTINUOUS- NORMAL switch (EXCITER PLATE POWER switch on some models)	NORMAL (OFF on some models)
Matching unit	Function switch	POWER
	Adjust control	COUNTER- CLOCKWISE
Fsk-modulator.....	POWER switch.....	OFF
Control unit	POWER switch.....	OFF
	BIAS POWER ON-OFF	OFF
Converter	POWER switch (under Channel A)	OFF
Each receiver.....	FUNCTION switch.....	OFF
Speaker assembly	CHANNEL A	OFF
	CHANNEL B.....	OFF
Blower Assembly, Electrical	HD-223/G	POWER switch..... OFF
Reperforator.....	POWER switch.....	OFF
	LIGHT switch.....	OFF
	SEND-LOCK switch	LOCK
Page printer	MOTOR switch.....	OFF
	LIGHT switch.....	OFF
	SEND-LOCK switch	LOCK

3-7. Starting Procedure

With the controls set as outlined in paragraph 3-6,

Preliminary Starting Procedures, perform the procedures indicated below to apply power to the equipment.

Component	Control	Position
Power unit.....	START button	Press START- STOP switch to START position and release when engine oil pres- sure reaches 20 PSI.
Switch Box SA-331	POWER SUPPLY switch NO. 1 or NO. 2	depending on gen- erator in use.
Power unit.....	Circuit breaker	ON
Shelter	Circuit breakers.....	ON
Transmitter	FILAMENT POWER circuit breaker.....	ON
	FILAMENT VOLTAGE control	Adjust for a read- ing of 5 to 5.2 on FILAMENT VOLTAGE meter.
Fsk modulator....	POWER switch	ON
Control unit	POWER switch	ON
	BIAS POWER switch	ON
Blower Assembly Electrical	HD-223/G.....	POWER switch
Speaker assembly	Desired CHANNEL switch	ON
Each Receiver R-390(*)/ URR	FUNCTION switch.....	AGC
Converter.....	POWER switch	ON

NOTE

For one-way reversible (half duplex) operation, only one receiver is normally in use. The remaining receiver is preset for possible emergency use in full duplex operation.

3-7.1. Presetting and Calibration Procedures

With the controls set as indicated in paragraph 3-7, perform the following procedures:

a Presetting Receiver and Converter.

Component	Control	Position
Converter.....	AFC switch.....	OFF (under Channel B)
	AFC SHIFT ADJUSTMENT	Set to 0
	AFC THRESHOLD LEVEL	OFF
	CHANNEL SELECTOR	A or B (determined by receiver in use)
	MARK HOLD-XTAL AFC switch	MARK HOLD
	DRIFT INDICATOR.....	Set to O

Receiver.....	LINE METER switch.....	OFF
	LINE GAIN	Set to 0
	ANTENNA TRIM.....	Set to 0
	AGC	FAST
	LIMITER	OFF
	AUDIO RESPONSE	SHARP
	BREAK IN switch.....	OFF
	BANDWIDTH switch	0.1 KC
	BFO PITCH	Set to 0
	BFO.....	ON
	DIAL LOCK	Fully
		counterclockwise
		(ccw)
	ZERO ADJUST	Fully ccw
	LOCAL GAIN.....	Set to 0
	RF GAIN.....	10
	KILOCYCLE	
	CHANGE.....	Set to assigned frequency
	MEGACYCLE	
	CHANGE.....	Set to assigned frequency

b Receiver Calibration.

Component	Control	Position
FUNCTION switch	CALIBRATE)	
LOCAL GAIN	Set to comfortable listening level	
KILOCYCLE CHANGE	100 KC setting closest to assigned frequency	
ZERO ADJUST	Fully clockwise	
KILOCYCLE CHANGE	Adjust for zero beat	

NOTE

It may be necessary to change the AUDIO RESPONSE switch to WIDE and to increase the setting of the BANDWIDTH switch to obtain a zero beat.

Component	Control	Position
ZERO ADJUST	Fully ccw	
FUNCTION switch	AGC	
KILOCYCLE CHANGE	Set to assigned frequency	
BANDWIDTH KC switch ...	8	
LOCAL GAIN	Set to 0	
AUDIO RESPONSE switch ..	WIDE	

c Presetting Control Unit.

Component	Control	Position
SIDETONE switch.....	OFF	
HYBRID BALANCE switch	Arrow is pointing upwards	
REMOTE TEL switch	LOCAL TEL	
TELETYPE switch.....	NORMAL-OW	

d Switch SA-12J3/GRC. The SA-1253/GRC SECURITY INSTALLED-REMOVED switch is set to the applicable position indicating the security (crypto) equipment is REMOVED or INSTALLED.

e Fsk-Modulator. The fsk-modulator BAND SELECTOR switch is set to the band corresponding to the assigned operating frequency.

f Transmitter Presetting and Calibration.

Component	Control	Position
600 OHM LINE GAIN.....	Fully ccw	
CARBON MIKE GAIN.....	Fully ccw	
MODULATOR BIAS.....	Fully ccw	
SERVICE SELECTOR switch...	FSK	
BAND SELECTOR switch	Set to band corresponding to assigned frequency	
TUNING CONTROL	Set to assigned frequency	
EXCITATION METER SWITCH	PA GRID X2	
PA BAND SWITCH.....	Set to band corresponding to assigned frequency	
POWER AMPLIFIER		
LOADING.....	28.0	
POWER AMPLIFIER TUNING	Set in accordance with CALI	

g Tuning Unit Presetting and Calibration.

Component	Control	Position
FREQUENCY INCREASE.....	See CALIBRATION CHART on side of the transmitter (or in TM 11-80910)	
COUPLING.....	See CALIBRATION CHART	
RANGE Switch	See CALIBRATION CHART	

NOTE

When operating in the 10 to 20 MHz range, the LOW FREQUENCY INCREASE control for the 2 to 10 MHz range must be set to 30.0

3-8. Tuning Procedures

With the controls set as described in paragraph 3-7.1, perform the procedures in subparagraph a below to tune the transmitter when using a whip or long wire antenna. Perform the procedures in subparagraph b below for a doublet antenna.

NOTE

In the unlettered model transmitter, the KEYING switch is labeled EXCITER PLATE POWER and the NORMAL and CONTINUOUS positions of the KEYING switch correspond to OFF and ON respectively. In the A or C model transmitter procured on Order No. 28459-Phila-55, the TUNE-OPERATE switch is panel marked, TUNE-NORMAL. The NORMAL position corresponds to the OPERATE position.

a Tuning Procedure With Whip or Long-Wire Antenna.

(1) Set KEYING CONTINUOUS-NORMAL switch on the transmitter to KEYING CONTINUOUS. (EXCITATION meter should read upscale).

(2) Set LOCAL GAIN control on receiver to a comfortable listening level.

(3) Set BANDWIDTH KC switch on receiver to 0.1 and the AUDIO RESPONSE control to SHARP.

NOTE

If difficulty in zero beating is encountered, set BANDWIDTH KC switch to 8 and the AUDIO RESPONSE control to WIDE.

(2) Adjust the TUNING CONTROL on the transmitter until a zero beat is heard in the speaker. The transmitter frequency is now the same as that indicated on the frequency indicator on the receiver, regardless of any small difference from the transmitter dial indication.

(3) Set the KEYING CONTINUOUS-NORMAL switch on the transmitter to NORMAL.

(6) Set the LOCAL GAIN control on the receiver to 0.

CAUTION

The receiver will be damaged if the BREAK IN switch is left in the OFF position.

(7) Set the BREAK IN switch on the receiver to ON.

(8) Set the PLATE POWER circuit breaker on the transmitter to ON.

(9) Set the PLATE RELAY switch on the transmitter to the up position.

(10) Set the KEYING CONTINUOUS-NORMAL switch on the transmitter to CONTINUOUS.

CAUTION

When the matching unit control switch is set to POWER, ADJUST, or SWR, full transmitter output power is dissipated in the dummy load of the matching unit. To avoid damage to the unit, do not apply power continuously for longer than 10 minutes.

(11) Adjust the POWER AMPLIFIER TUNING control on the transmitter for a "dip" (minimum) on the PA PLATE meter.

(12) Adjust the POWER AMPLIFIER LOADING control on the transmitter clockwise for a reading of 150 ma on the PA PLATE meter.

(13) Adjust the POWER AMPLIFIER TUNING control on the transmitter counterclockwise for a "dip" (minimum) on the PA PLATE meter.

(14) Adjust the POWER AMPLIFIER LOADING control on the transmitter clockwise for a reading of 150 ma on the PA PLATE meter.

(15) Repeat steps (13) and (14) until a reading of 150 ma is attained and no "dip" is observed when the POWER AMPLIFIER TUNING control only is turned counterclockwise.

NOTE

The matching unit meter indicates the amount of power produced by the transmitter.

(16) Set the KEYING CONTINUOUS-NORMAL switch on the transmitter to NORMAL.

(17) Set the TUNE-OPERATE switch on the transmitter to OPERATE.

(18) Set the KEYING CONTINUOUS-NORMAL switch to CONTINUOUS.

(a) The FILAMENT VOLTAGE meter should indicate 5 to 5.2 volts.

(b) The EXCITATION meter should indicate a reading of 8 milliamperes minimum.

(c) Turn the EXCITATION METER SWITCH to the INT AMP PLATE X10 position. The EXCITATION meter reading should be between 20 and 70 ma.

CAUTION

Current in excess of 70 milliamperes will cause damage to the IPA tube and greatly reduce its life expectancy.

(19) Adjust the POWER AMPLIFIER TUNING control on the transmitter to obtain a minimum reading on the PA PLATE meter.

(20) Adjust the POWER AMPLIFIER LOADING control for a reading of 350 ma.

(21) Repeat steps (19) and (20) until a reading of 350 ma is attained and no "dip" is observed when the POWER AMPLIFIER TUNING control is turned.

NOTE

A maximum indication on the PA PLATE meter should not exceed 350 ma for CW or FSK operation and 275 ma for AM, VOICE or FSK-AM, operation.

(22) Set the KEYING CONTINUOUS-NORMAL switch to NORMAL.

(23) Set the control switch on the matching unit to ADJUST.

(24) Set the transmitter KEYING CONTINUOUS-NORMAL switch to CONTINUOUS.

(25) Turn the ADJUST control on the matching unit to obtain a full scale reading of 600 or a maximum if the 600 is not obtainable.

(26) Set the transmitter KEYING CONTINUOUS-NORMAL switch to NORMAL.

(27) Set the control switch on the matching unit to SWR.

(28) Set the transmitter KEYING CONTINUOUS-NORMAL switch to CONTINUOUS.

(29) Adjust the FREQUENCY INCREASE control on the tuning unit (TN-339/GR) to obtain a minimum reading on the meter of the matching unit.

(30) Adjust the COUPLING control on the tuning unit to obtain a minimum reading on the meter of the matching unit.

(31) If a minimum reading at this time is not in the green area of the matching unit meter, repeat steps (29) and (30) alternately until a green area reading is obtained.

CAUTION

If the transmitting antennas of two or more radio sets are close together, coordinate tuning operations so that one set is not transmitting while the control switch of the matching unit in the other set is in the SWR position. Power radiated from a nearby antenna can cause damage to resistors in the matching unit.

NOTE

If the minimum swr is 1.5 to 1 or higher, check for loose connections and make sure that the roller contacts in the tuning unit are clean. At frequencies above 17 MHz, if a 1:1 swr cannot be obtained, remove the top antenna section and readjust the tuning unit.

(32) Set the transmitter KEYING CONTINUOUS-NORMAL switch to NORMAL.

(33) Set the control switch on the matching unit to OPERATE.

NOTE

Minor readjustment of the transmitter POWER AMPLIFIER TUNING and POWER AMPLIFIER LOADING controls may be necessary to obtain a PA PLATE meter indication of 350 ma for cw or fsk operation and 275 ma for am. or fsk-am. operation.

b. Tuning Procedure with Doublet Antenna.

(1) Follow the procedure given in subparagraph a(1) through (28) above.

NOTE

The swr cannot be corrected by adjusting the transmitter. The swr can only be improved by correcting the antenna length for the operating frequency. The formula for antenna length is based on average conditions. The antenna length may be different from calculated length because of ground conditions, antenna height, or proximity of trees and buildings.

(2) Read the swr on the matching unit meter. It may be as high as 2:1. If the meter indicates above 2, check for loose or broken connections in the antenna lead and make sure that the antenna is not touching trees, wires, or other obstructions. If the meter still indicates above 2, the antenna must be shortened or lengthened physically.

(3) If the meter on the matching unit does not read in the white (2:1) or green area, set the KEYING CONTINUOUS-NORMAL switch to NORMAL.

(4) Lengthen or shorten the antenna.

(5) Recheck the swr by setting the KEYING CONTINUOUS-NORMAL switch to CONTINUOUS and read the meter.

(6) Set KEYING CONTINUOUS-NORMAL switch to NORMAL.

(7) Perform (3) through (6) alternately until a satisfactory swr reading is obtained.

(8) Set CONTROL switch on the matching unit to OPERATE.

3-9. Operating Conditions

One of several operating conditions can be used, depending on the existing situation. The radio set is capable of mobile or mobile-at-halt operation.

a. Mobile Operation. In this type of operation the radio set is used while in motion. The tied-down whip antennas are used for transmission and reception of signals. One-way reversible operation is usually employed whereby the transmitter and receiver do not operate simultaneously. When the transmitter is used, the receivers (or receiver) are disabled; when the receivers are used, the transmitter is disabled. The transmitter and receivers can use the same frequency in this type of operation.

b. Mobile-at-Halt Operation. In this type of operation, the radio set is stopped but may be moved again. The doublet antennas may be erected for transmission and reception of signals. Duplex operation can be used instead of one-way reversible operation. In duplex operation, the transmitter and receiver should operate on frequencies separated by at least 400 kHz. This separation makes it possible for the radio set to transmit and receive at the same time without interference between the transmitter and the receiver.

c. Operating Procedures. The radio set may be operated either locally (within the shelter) or from a remote site (at a maximum distance of 10 miles). Operation is possible in any one of four modes: fsk, fsk-am, am, voice, and cw. The control unit is the control center for the radio set. All signals to or from the teletypewriter equipment and from a microphone or key are routed through the control unit. To operate the radio set, start and tune the equipment as instructed in paragraphs 3-6 through 3-8, and follow the procedure for the desired type of operation as discussed in paragraphs 3-10 through 3-13.

3-10. Fsk Operation

The signals from the sending teletypewriter equipment pass through the security equipment or junction boxes, through the control unit and polar relay to key the fsk modulators, which in turn keys the transmitter.

The receiving teletypewriter equipment is actuated by signals received from the two receivers, the converter, the control unit, and the secure gear or / junction boxes. The four-position TELETYPE switch

on the control unit selects the type of teletypewriter operation desired. Two positions are used with local operation and two are used with remote operation.

a. Fsk One-Way Reversible (Half-Duplex) Operation from Shelter.

(1) Turn the security equipment power switch ON (if installed).

(2) Turn the page printer (send teletype) MOTOR and LIGHT switch ON.

(3) Place the SEND-LOCK switch to SEND position.

(4) Adjust the BIAS ADJUST for a reading of 60 ma on the bias meter of the control unit.

(5) Rotate the TUNING CONTROL on the transmitter for maximum indication on the converter SIGNAL INPUT meter, and an indication of 50 to the right of 0 on the converter DISCRIMINATOR meter.

NOTE

This requires only a very slight movement of the tuning control.

(6) Activate security equipment (if installed).

(7) Depress spring loaded LINE BREAK switch on the page printer to obtain a reading of 50 to the left of 0 on the DISCRIMINATOR meter. If unable to obtain the reading of 50 to the left, recheck the transmitter TUNING CONTROL.

(8) Place the SEND-LOCK switch on the page printer to the LOCK position.

(9) The AN/GRC-26D is now ready to operate in the FSK mode of operation. In order to print an incoming signal it must be noted that the MARKHOLD-XTAL switch on the converter must be placed on the XTAL left position to allow the incoming signal to pass to the teletype equipment.

(10) For sending a prepared tape from the reperforator, set the SELECTOR switch to position 1 and the send page printer SEND-LOCK switch to the SEND position. Insert the tape into the transmitter-distributor and operate the START-STOP-FEED RETRACT switch to START. The page printer and reperforator will print page and tape copy, respectively. The teletypewriter message will be transmitted.

b. Fsk Duplex Operation From the Shelter. For fsk duplex operation, perform the tuning procedures in paragraphs 3-6 through 3-8 before performing the following procedures:

(1) Set the control unit TELETYPE switch to NORMAL DX.

(2) Turn the secure equipment power switch (if installed) to the ON position.

(3) Set the receive page printer MOTOR and LIGHT switches to ON.

(4) Turn the reperforator POWER, LIGHT, and MOTOR switches to ON.

(5) Turn the POWER switch of the converter to the ON position; allow the converter to warm up.

(6) Set the teletype SEND-LOCK switch to the SEND position.

(7) Tune receiver A for the teletype signal following the procedures from TM 11-5820-358-10 (R390A/URR).

NOTE

When operating duplex, make sure that the difference between the transmitter frequency and receiver frequency is at least 400 kHz.

(8) Slowly retune radio receiver A while observing the channel A discriminator meter until the meter needle deflects to the right and to the left for miscellaneous keying signals. The deflections will be of approximately equal plus and minus values when the receiver is correctly tuned. The reading on the SIGNAL INPUT meter should be at a maximum for the station being tuned in.

(9) Rotate the CHANNEL SELECTOR switch to position A. (10) Rotate the channel A AFC-XTLMARK-HOLD switch to the right or left AFC position corresponding to the XTAL position required for correct copy and immediately turn the channel A AFC SHIFT ADJUSTMENT until the AFC INDICATOR stops spinning. The teletypewriter should start printing.

(11) Adjust the channel A AFC THRESHOLD LEVEL control knob to the highest clockwise reading that does not allow weak signals to operate the teletypewriter. A practical way to recognize this setting is to advance the control knob several divisions from the OFF position and check to see that the teletypewriter is printing correct copy. If the teletypewriter starts printing garbled copy, advance the control knob clockwise. The setting of the control knob is subject to change due to different transmission conditions. A steady mark conditions results when the transmitting station shuts down or when the signal level drops below the level set by the AFC THRESHOLD LEVEL.

(12) If receiver B is being used, perform the procedures in (8) through (10) above using the B side of the converter.

c. Fsk One-Way Reversible (Half-Duplex) Operation from Remote Site. For fsk half-duplex operation from the remote site, perform the tuning procedures in paragraph 3-6 through 3-8 above and the following:

(1) Connect the remote equipment to the shelter as shown in figures 2-8 or 2-9.

(2) Adjust the equipment as indicated in paragraph 3-11a and set the control unit TELETYPE switch to REMOTE OW.

(3) To monitor the remote site at the shelter, set the send page printer SEND-LOCK switch to LOCK and set the reperforator SEND-LOCK switch to LOCK. Adjust the remote site equipment as follows:

(a) Set the teletypewriter POWER, MOTOR, and LIGHT switches to ON.

(b) Set the teletypewriter SEND-LOCK switch to LOCK.

(c) The radio set can now be keyed and un-keyed from the remote site control unit (C 1474/GRC). The page printer will monitor both the received and transmitted signals.

d. Fsk Duplex Operation from Remote Site. With the shelter equipment set as indicated in subparagraph c above, set the control unit TELETYPE switch to REMOTE DX. Monitoring the remote site at the shelter can be achieved by setting the page printer SEND-LOCK switch to LOCK and the reperforator SEND-LOCK switch to LOCK. Adjust the remote site equipment as follows:

(1) Set the receive page printer POWER, MOTOR, and LIGHT switches to ON.

(2) Set the receive page printer SEND-LOCK switch to LOCK.

(3) Set the send page printer POWER, MOTOR, and LIGHT switches to ON.

(4) Set the send page printer SEND-LOCK switch to SEND and operate from the remote site.

3-11. Am. Voice Operation

For am. voice operation, perform the tuning procedures in paragraphs 3-6 through 3-8. Then adjust the equipment as indicated below:

a. Am. Voice Half Duplex Operation from Shelter.

(1) Tune and adjust receiver A for a voice signal (see TM 11-5820-357-10 for the R-390/URR or M 115820-358-10 for the R-390A/URR).

(2) Connect the microphone to the MIC or KEY jack on the control unit (C-1123/GRC).

(3) Place EXCITATION METER switch on the transmitter to MOD PLATE X20.

(4) Place SERVICE SELECTOR switch on the transmitter to AM.

(5) Set PLATE RELAY switch on the transmitter to OFF.

(6) Press the PUSH TO TALK switch on the microphone and adjust the MODULATOR BIAS control on the transmitter until a reading of 2.5 is obtained on the EXCITATION meter (50 ma.).

(7) Speak normally into the microphone and adjust the CARBON MIKE GAIN control on the transmitter for a maximum reading of 230 ma. on the EXCITATION METER. If 230 ma. is not exceeded on the peaks, the transmitter is adjusted for 100 percent

modulation with peak clipping control for modulation over 100 percent modulation.

(8) Release the PUSH TO TALK switch; the radio set is ready for operation.

b. Am. Voice Duplex Operation from Shelter. To operate am. voice duplex, perform the procedures indicated in subparagraph a above, tune receiver A as indicated in paragraph 3-8b (for receiving), and perform the following procedures.

CAUTION

Receiving and transmitting frequencies must be separated by at least 400 kHz to prevent damage to the receiver.

(1) If transmission and reception from the telephone set is desired, set the control unit REMOTE TEL switch to REC A.

(2) Press the shelter telephone set PUSH TO TALK switch.

(3) Adjust the control unit HYBRID BAL control for the same amount of modulation at the transmitter as indicated in subparagraph a (6) and (7) above.

(4) Release the PUSH TO TALK switch.

(5) The received signal is heard at the shelter telephone set, press the PUSH TO TALK switch and talk into the telephone set to transmit.

c. Am. Voice Duplex Operation from Remote Site. The following procedures supplement the procedures indicated in subparagraph b above.

(1) Connect the remote equipment to the shelter as indicated in figures 2-8 or 2-9.

(2) Set the remote control unit XMTR switch to ON.

(3) Operate the remote telephone PRESS TO TALK switch and talk into its microphone. The remote telephone may be monitored on the shelter telephone set. The remote or shelter telephone may modulate the transmitter.

(4) Adjust the control unit HYBRID BAL control, in the shelter, for the same amount of modulation at the transmitter from the remote and the shelter telephones.

(5) Release the PRESS TO TALK switch; the radio set is ready for operation.

d. Am. Voice Half-Duplex Operation from Remote Site. The following procedures supplement the procedures in subparagraphs b and c above.

(1) Tune receiver A to the same frequency as the transmitter.

NOTE

The receiver is disabled during transmission when operating one-way reversible (half duplex).

(2) Set the remote control unit XMTR ON switch to ON.

(3) Operate the remote telephone set PRESS TO TALK switch and speak into the mouthpiece to transmit.

(4) Set the remote control unit XMTR ON switch to its OFF position to receive incoming messages.

3-12. Fsk-Am. Operation

To operate the radio set in the fsk-am. mode, perform the tuning procedures indicated in paragraphs 3-6 through 3-9 and then proceed as follows:

a. Turn transmitter SERVICE SELECTOR switch to FSK-AM.

b. Adjust the radio set for fsk operation as instructed in paragraph 3-11a,b, c, or d, as applicable (OWR or DUPLEX and local or remote).

c. Adjust the radio set for am. operation as instructed in paragraph 3-11a, b, c, or d, as applicable.

3-13. Cw Operation

For cw operation, perform the tuning procedures in paragraphs 3-6 through 3-9. Adjust the receiver in accordance with instructions provided in figure 11, TM 11-5820-358-10 (R-390A/URR); proceed as follows:

a. *Cw Half-Duplex (OWR) Operation from Shelter.*

(1) Connect a key to the MIC or KEY jack on the control -unit. (2) Set the control unit SIDETONE switch to the receiver (RCVR A or RCVR B) being used.

NOTE

The receiver is disabled when transmitting cw.

(3) Press the key to transmit cw; release the key to receive cw.

b. *Cw Duplex Operation from Shelter.*

(1) Perform the procedures indicated in subparagraph a (1) and (2) above.

(2) Tune receiver B as in paragraph 3-7.1 and adjust the receiver according to figure 11, TM 115820-358-10 (R-390A/URR).

(3) Set the transmitter SERVICE SELECTOR switch to CW.

CAUTION

The receiver is not disabled during transmission.

(4) The radio set is operational.

c. *Cu, Operation from Remote Site.* No provisions are made for normal cw operation from the remote site. In an emergency, cw operation is possible as follows:

(1) Adjust the equipment as indicated in subparagraph a above.

(2) Set the control unit TELETYPE switch to REMOTE OW.

(3) Connect the key to the remote site control unit CONTROL terminals. (This connection parallels

the TTY SWITCH jack and XMTR ON switch of the remote control unit.)

(4) Press the key to transmit.

3-14. Recognition and Identification of Jamming

Under real or simulated tactical conditions, the receiver may be jammed by the enemy. Jamming is easily accomplished by transmitting a strong signal on the same frequency, thereby making it difficult or impossible to hear the desired signal. Unusual noises or strong interference heard on the receive may be enemy jamming, signals from a friendly station, noise from a local source, or noise caused by a defective receiver. To determine whether or not the interference is originating in the receiver, disconnect the antenna, remove the antenna, or short-circuit the antenna post to the chassis. If the interference continues, the receiver is defective. Enemy jamming signals may be typed as continuous-wave or modulated.

A jamming signal may be intended to block a single frequency. This is called spot jamming. The enemy may use one or several transmitters to jam a block or band of frequencies. This method is called barrage jamming.

a. *Continuous-Wave Jamming.* Cw jamming is transmitted as a steady carrier. This signal beats with another signal and produces a steady tone in the speaker assembly. Cw jamming signals may also be keyed by using a random on-and-off signal or using actual code characters keyed at the same rate or a little faster than the signal being received.

b. *Modulated Jamming.* Modulated jamming signals may consist of noise, laughter, singing, music, various tones, or almost any unusual sound, or they may be a combination of these sounds. Various types of modulated jamming signals are explained below.

(1) *Spark.* This is one of the simplest, most effective, and most easily produced jamming signals. This type of signal sounds rough, raspy, and sometimes like an electric motor with sparking brushes running. This signal is broad; therefore, it will interfere with a large number of communication channels.

(2) *Sweepthrough.* This signal is the result of sweeping or moving a carrier back and forth across the same frequency at a slow or rapid rate. The numerous signals of varying amplitude and frequency produce a sound like that of a low-flying airplane passing overhead. This type of jamming is effective over a broad range of frequencies. When it is varied rapidly, it is effective against all types of voice signals.

3) Stepped tones or bagpipes. This signal usually consists of several separate tones. The tones are transmitted in the order of first increasing and then decreasing pitch, repeated over and over. The audible effect is similar to the sound of a Scottish bagpipe.

(4) Noise. Noise is random both in amplitude and frequency. It is considered one of the better types of jamming modulation. It produces a sound similar to that heard when a receiver is not tuned to a station and the volume or gain control is turned to maximum.

(5) Gulls. This signal consists of a quick rise and slow fall of a variable audiofrequency. The sound is similar to the cry of the sea gull.

(6) Tone. This signal consists of a single audio frequency of varying tone. It produces a steady howl in the speaker assembly. Another use of tone is to vary it slowly. It produces a howling sound of varying pitch.

3-15. Antijamming

When it is known that a receiver is being jammed, the operator should notify his immediate superior immediately and continue to operate the equipment. To provide maximum intelligibility of jammed signals, follow the operational procedure indicated for each type of operation.

a. When receiving frequency-shift signals, follow the procedures in (1) through (9) below in sequence until clear copy is printed.

(1) Set the BANDWIDTH KC switch to .1.

(2) Adjust the ANT TRIM control for a maximum readable output signal.

(3) If the noise is severe, adjust the LIMITER control.

(4) When the jamming signal is not very strong, set the FUNCTION switch to MGC and turn the RF GAIN control down. The interfering signal might be reduced enough to permit part of the desired signal to come through.

(5) Set the FUNCTION switch to AGC, and try different time constants.

(6) Do not use afc on the converter.

(7) Try different and more high directional antennas.

(8) If the procedures in (1) through (7) above do not provide some degree of signal separation, request a change in frequency and call sign.

(9) If jamming action is such that communication is impossible, report this fact to your immediate superior. Continue to operate the equipment.

b. When receiving voice signals and the receiver is being jammed, follow the procedures in (1) through (3) below in sequence until the signal is heard with the least interference.

(1) Rotate the KILOCYCLES CHANGE control slowly through several dial markings on either side of the desired signal. Some separation of the desired L signal from the jamming signal may be achieved.

(2) Set the BANDWIDTH KC switch to 4 or 2, whichever gives the best results. Slowly tune as described in (1) above.

(3) Perform the procedures in a(2) through (5) and (7) through (9) above.

c. If the receive is being jammed when receiving cw signals, follow the procedures in (1) through (4) below in sequence until satisfactory reception is established.

(1) Rotate the KILOCYCLES CHANGE control slowly through a few dial markings on either side of the desired signal. Some separation of the desired signal from the jamming signal may be achieved.

(2) Set the BANKWIDTH KC switch to 1 or .1, and set the AUDIO RESPONSE switch to SHARP. Slowly tune as described in (1) above.

(3) Reset the BFO PITCH control; it may be possible to separate the pitch of the desired signal from the jamming signal to provide readability.

(4) Perform the procedures in A(2) through (5) and (7) through (9) above.

3-16. Stopping Procedure

The radio set may be disabled by setting the shelter main circuit breakers to OFF or by pressing the STOP button on the power unit. Use this disabling procedure only as an emergency measure, since the individual components must be set to their respective off positions before restarting. To perform the normal stopping procedure for the individual components, set the controls as given in the chart below.

Component	Control	Position
Each page printer	SEND-LOCK SWITCH	LOCK
	MOTOR and LIGHT switches	OFF
Reperator	LIGHT, MOTOR and POWER switches	OFF
Transmitter	PLATE RELAY switch	OFF(down)
	PLATE POWER circuit breaker	OFF(down)
Fsk-modulator	POWER switch	OFF(down)
Matching unit	SELECTOR switch	POWER
	METER ADJUST control	Full ccw
Control Unit	BIAS POWER switch	OFF
	AC POWER switch	OFF(down)
Converter	POWER switch	OFF(down)
Each receiver	FUNCTION switch	OFF

Component	Control	Position
Speaker assembly	CHANNEL A and B switches	OFF(down)
Blower assembly	Power switch	OFF(down)
Transmitter	FILAMENT POWER circuit breaker	OFF(down)
Shelter	Circuit breakers	OFF
Power Unit	Circuit breaker	OFF
	START-STOP switch	PRESS TO STOP

Change 4 3-15

CHAPTER 4

MAINTENANCE INSTRUCTIONS

4-1. Scope of Operator's Maintenance

The maintenance duties assigned to the operator of Radio Set AN/GRC-26D are listed below, together with a reference to the paragraphs covering the specific maintenance function. The duties do not require tools or test equipment other than those issued with the set.

- a. Daily preventive maintenance checks and services (para 4-5).
- b. Weekly preventive maintenance checks and services (para 4-6).
- c. Cleaning (para 4-7).
- d. Lubrication (para 4-8).
- e. Maintenance checks (para 4-9).
- f. Replacement of defective fuses (para 2-7).
- g. Checking cable connections (para 2-9).

4-2. Tools Required for Maintenance

The tools required for maintenance are listed in appendix B and illustrated in figures B-1, B-2, and B-13.

4-3. Preventive Maintenance

Preventive maintenance is the systematic care, servicing, and inspection of equipment to prevent the occurrence of trouble, to reduce downtime, and to assure that the equipment is serviceable.

a. *Systematic Care.* The procedures given in paragraphs 4-1 through 4-9 cover systematic care essential to proper upkeep and operation of the equipment. The cleaning operations (para 4-7) should be performed once a day. If the equipment is not used daily, however, the cleaning operations must be performed before operation after any extended shutdown, or once a week while the equipment is kept in standby condition.

b. *Maintenance Service and Inspection.* The maintenance checks and services charts (para 4-5 and 4-6) outline inspections to be made at specific intervals. These inspections are made to determine that the equipment is in good general (physical) condition, in good operating condition, and likely to remain combat

serviceable. To assist operators in maintaining combat serviceability, the charts indicate what to inspect, how to inspect, and what the normal conditions are; the References column lists the paragraph or illustrations that contain additional information. If the defect cannot be remedied by the operator, higher category maintenance or repair is required.

Records and reports of these inspections must be made in accordance with TM 38750.

4-4. Maintenance Checks and Services Periods

Maintenance checks and services of the AN/ GRC-26D are required on a daily and weekly basis.

a. Paragraph 4-5 specifies checks and services that must be accomplished daily and under the special conditions listed below:

- (1) Vehicular installation.
 - (a) Before the vehicle starts on a mission.
 - (b) When the equipment is initially installed.
 - (c) When the equipment is reinstalled after removal for any reason.
 - (d) At least once each week if the equipment is maintained in standby condition.
- (2) Transportable and mobile installations.
 - (a) When the equipment is initially installed.
 - (b) When the equipment is reinstalled after removal for any reason.
 - (c) At least once a week if the equipment is maintained in standby condition.

b. Paragraph 4-6 specifies maintenance checks and services that must be performed once each week. If the equipment is being maintained in a standby condition, the daily (para 4-5) and weekly (para 4-6) checks and services should be accomplished at the same time.

4-5. Daily Preventive Maintenance Checks and Services Chart

<i>Sequence</i>			
<i>No.</i>	<i>Item to be Inspected</i>	<i>Procedure</i>	<i>Reference</i>
1	Completeness	Inspect equipment for completeness	Appx B.
2	Installation	Inspect equipment for proper installation.	Para 2-1 through 2-10.
3	Cleanliness.....	Units must be clean and dry inside and out and free of dirt, grease, corrosion, and fungus.	Para 4-7.
4	Cables	All cables must be free of cuts, cracked or gouged jackets, fraying, or kinks.	Fig. 2-7, 5-1, and 5-2.
5	Meters	Meters must be free of chips and cracks. Indicator should be straight and move freely.	
6	Antenna	Insulators are free of cracks, dirt, and fungus. Mast sections are not bent. Guy wires and transmission lines are not kinked and do not show signs of fraying.	
7	Hardware	Catches, hinges, latches, and handles must be in good condition without broken or missing components.	
8	Plugs and receptacles	Plugs and receptacles shall be firmly seated and free from chips and breaks.	
9	Controls	Controls should move freely without binding. Knobs must be tight on the shafts.	
10	Operating check	Check the radio set for proper operation	Para 3-5 through 3-13 and 3-16.

4-6. Weekly Preventive Maintenance Checks and Services Chart

<i>Sequence</i>			
<i>No.</i>	<i>Item to be Inspected</i>	<i>Procedure</i>	<i>Reference</i>
1	Interlocks	Inspect for evidence of failure	
2	Knobs, dials, and switches	Check for proper mechanical action by setting each control to each of its settings.	
3	Mountings.....	Inspect seating and stability of mountings. Check for loose or missing hardware.	
4	Canvas and leather	Check to see that items are free from mildew, tears, and fraying.	
5	Air filters	Check to see that air filters are clean.	
6	Storage batteries	Check to see that batteries are free from dirt, corrosion, and leakage.	
7	Shelter	Shelter must be in good condition and free from leaks. Weatherproofing must be in good condition.	

4-7. Cleaning

Inspect the exteriors of the units within the shelter. The exterior surfaces should be clean and free of dirt, grease, and fungus.

a. Remove dust and other loose dirt with a clean, soft cloth.

WARNING

Prolonged breathing of cleaning compound is dangerous; make certain that adequate ventilation is

provided. Cleaning compound is flammable; do not use near a flame. Avoid contact with the skin; wash off any that spills on the hands.

b. Remove grease, fungus, and ground-in dirt from the cases; use a cloth dampened-(not wet) with Cleaning Compound (FSN 793043959542).

c. Remove dirt from plugs and jacks with a brush.

CAUTION

Do not press on the meter faces (glass) when cleaning; the meter may be damaged.

d. Clean the front panels and control knobs; use a soft, clean cloth. If dirt is difficult to remove, dampen the cloth with water; mild soap may be used to make the cleaning more effective.

4-8. Lubrication Instructions

a. General.

(1) The type of lubricant to be used, the interval, and the specific instructions for each component of the radio set are given in their respective technical manuals (appx A). Lubrication for the shelter ventilator blower is given in b below.

(2) Apply Lubricating Oil, General Purpose (FSN 9150-185-0629) (FED VV-I800) sparingly to springs and loops of all helical springs, to prevent wear and rust.

b. Shelter Ventilating Blower (fig. 1-9). Lubricate the shelter ventilating blower with Lubricating Oil, Engine (FSN 9150-265-9425) (MILL2104). Oilcups are located at each end of the motor.

c. Mechanical Devices of Shelter. Lubricate all movable parts of the shelter, such as hinges, latches, etc, with a light coat of oil (MIL-L2104) to insure against rust and corrosion and to provide for better operation. Wipe off excess lubricant to prevent contamination by dirt.

d. Raceways of Cabinet. The raceways of cabinets should be lubricated with oil (FED VVL-800) to assure easy removal of chassis for repairs.

4-9. Maintenance Checks

When the equipment fails to perform properly, remove power from the radio set and make the checks listed in a through d below. If this fails to correct the trouble, repeat the starting and tuning procedures described in paragraphs 3-6 through 3-8, and repeat the applicable operating procedure described in paragraphs 3-10 through 3-13. If a page printer or a receiver appears to be in trouble, the second page printer or receiver, as applicable, may be substituted as described in e and f below. The transmitter may be checked as described in g below. If these procedures fail to correct the trouble, note the specific trouble symptom and notify the supporting maintenance organization.

a. Improperly connected or loose cables and plugs (para 2-9a and c).

b. Poor ground connections (para 2-9).

c. Grounded or broken antennas or antenna lead-in wires (para 2-9a and c).

d. Burned-out fuses (para 2-7).

e. If a page printer is defective and one-way reversible operation is being used, the second page printer may be substituted for the one in trouble by disconnecting the cables at the control unit and connecting the identical cables from the second page printer in their place.

f. If the A-receiver is suspected of being in trouble, tune the B-receiver as described in paragraphs 3-6 through 3-8, and set the SIDETONE and REMOTE TEL switches on the control unit to REC B.

g. The transmitter may be checked by setting the control switch on the matching unit to POWER.

CHAPTER 5

**SHIPMENT AND LIMITED STORAGE AND DEMOLITION
TO PREVENT ENEMY USE**

Section I. SHIPMENT AND LIMITED STORAGE**5-1. Disassembly of Equipment**

The following instructions are recommended as a guide for preparing the radio set for transportation and storage.

- a. Disconnect any outside field wire lines. Disconnect the power cable from the power unit.
- b. Roll up the power cables, and store them in the shelter.
- c. Take down the doublet antennas, if used; disconnect the coaxial cables. Repack the antennas, and replace the cables on the reel.
- d. Disassemble the whip antennas if mobile operation is not anticipated. Store the antennas in the shelter.
- e. Disconnect the grounding wire, and remove the ground rod. Store the wire and ground rod in the shelter.
- f. Cover the page printers and reperforator with the canvas covers.
- g. Make sure that all components are mounted securely and fastened tightly.

h. Store all loose items, such as the microphone, key, and technical manuals, in the compartments of the storage cabinet.

i. Pack empty spaces in the storage cabinet to prevent shifting of contents. Close the cabinet drawers securely.

j. Close all windows, the roof hatch, and the feedthrough holes in the shelter.

k. Store the coaxial cables and reels, antenna mast equipment, power cables, and antenna wires in the shelter to prevent loss if the power unit trailer becomes separated from the shelter. Secure all these components to prevent shifting during transportation.

5-2. Repackaging for Shipment or Limited Storage

Repackaging a Radio Set AN/GRC-26D is performed at a higher maintenance category.

Section II. DEMOLITION OF MATERIEL TO PREVENT ENEMY USE**5-3. Authority for Demolition**

Demolition of the equipment will be accomplished only upon the order of the commander. The destruction procedures outlined in paragraph 5-4 will be used to prevent further use of the equipment.

5-4. Methods of Destruction

Use any of the following methods to destroy the equipment:

- a. Smash. Smash the controls, tubes, coils, switches, capacitors, transformers, and meters; use sledges, axes, handaxes, pickaxes, hammers, or crowbars.
- b. Cut. Cut all the interconnecting cables and power cables; use axes, handaxes, or machetes.

WARNING

Be careful when using explosives and incendiary devices. Do not use these items unless the need is extremely urgent.

c. Burn. Pack rags, clothing, or canvas under and around the components. Saturate this packing with gasoline, oil, or diesel fuel and ignite it. Burn cables and technical manuals; use gasoline, kerosene, oil, flame-throwers, or incendiary grenades.

d. Bend. Bend all panels and cabinets.

e. Explode. If explosives are necessary, use firearms, grenades, TNT, or artillery.

f. Dispose. Bury or scatter the destroyed parts in slit trenches or foxholes, or throw them into streams.

Figure 5-1. Shelter, Electrical Equipment S-56()/U, interunit cabling.*

(Located in back of manual)

Figure 5-2. Shelter, Electrical Equipment S-6()/U, interunit cabling (modified per MWO 11148S-564-5/1).*

(Located in back of manual)

APPENDIX A

REFERENCES

Following is a list of applicable references that should be available to the operator of Radio Set AN/GRC-26D:

DA Pam 310-4	Index of Technical Manuals, Technical Bulletins, Supply Manuals (types 7,8,' and 9), Supply Bulletins and Lubrication Orders.
DA Pam 310-7	U.S. Army Equipment Index of Modification Work Orders.
MWO 11-5820-256-35/1	Modification of Radio Set AN/GRC-26D to Provide Communication Security Facilities in Shelters S-56/G, S-56A/G, and S-56B/G.
SB 11-544	Limited Usage of Mast AB-155/U With Radio Beacon Set AN/GRN-6 Pending Redesign of Mast AB-360/G.
TB SIG 272	Microphone M-29A/U and M-29B/U.
TB SIG 291	Safety Measures To Be Observed When Installing and Using Whip Antennas, Field Type Masts, Towers, Antennas, and Metal Poles That Are Used With Communication, Radar, and Direction Finder Equipment.
TM 5-2805-259-14	Operator, Organizational, Direct Support, and General Support Maintenance Manual: Engine, Gasoline, 20 HP; Military Standard Models; (Model 4A084-2) (NSN 2805-00-925-3926 and (Model 4A084-3) (NSN 2805 00872-5972).
TM 5-6115-275-14	Operator, Organizational, Intermediate (Field), (Direct Support and General Support), and Depot Maintenance; Generator Set, Gasoline Engine Driven, Skid Mounted, Tubular Frame, 10 KW, AC, 120/208 V, 3 Phase: and 120/240 V Single Phase-Less Engine; DOD Model MEP-018A, 60 Hz (NSN 6115-00-889-1447) and DOD Model MEP-023A, 400 Hz (NSN 6115-00-926-0843).
TM 11-337	Telephone Sets TA-43/PT and TA-263/PT.
TM 11-809-10	Operator's Manual: Radio Transmitters T-368/URT, T-368A/URT, T-368B/URT, T-368C/URT, T-368D/URT, and T-368E/URT, Antenna, Tuning Unit BC-939B; Radio Frequency Tuner TN-339/GR; and Standing Wave Ratio-Power Meter ME-165/G.
TM 11-826	Radio Transmitters BC-610-E, -F, -G, -I and Radio Transmitter, T- 213/GRC-26, and Antenna Tuning Units BC-939-A and -B.
TM 11-2241	Frequency Shift Converters CV-116/URR, CV-116A/URR, CV-116B/URR and CV-116C/URR.
TM 11-3895-201-13P	Operator, Organizational, and Field (Third Echelon) Maintenance Repair Parts and Special Tool Lists and Maintenance Allocation Chart: Axles RL-27-B, RL-27-C, and RL27-D
TM 11-4140-200-10P	Operator's Repair Parts and Special Tools List: Blower Assembly, Electrical HD-223/G.
TM 11-5410-200-20P	Organizational Maintenance Repair Parts and Special Tools Lists; Shelters S-56/G, S-56A/G, and S-56B/G (FSN 5410-132-6679).
TM 11-5805-201-12	Operator and Organizational Maintenance Manual, Including Repair Parts and Special Tool Lists; Telephone Set TA-312/PT.
TM 115805-256-24P	Organizational, Direct Support, and General Support Maintenance Repair Parts and Special Tools Lists (Including Depot Maintenance Repair Parts and Special Tools): Telephone Set TA-43/PT (FSN 5805503-2775).
TM 11-5815-200-12	Operator's and Organizational Maintenance Manual Including Repair Parts and Special Tools List; Teletypewriter Sets AN/FGC-20, AN/FGC-20X, AN/FGC-21, AN/FGC-66, AN/FGC-159, AN/FGC-159X, AN/FGC-160, AN/FGC-177, AN/UGC-4, AN/UGC-29, AN/UGC-29X and Teleprinter TT-259/FG.

TM 11-5815-238-12	Operator's and Organizational Maintenance Manual Including Repair Parts and Special Tools List; Teletypewriter Sets AN/GGC-3 and AN/GGC-3A, AN/GGC-53 and AN/GGC-53A, and Teletypewriter Reperforator-Transmitters TT-76/GGC, TT-76A/GGC, TT-76B/GGC, TT-76C/GGC, TT-699/GGC, TT-699A/GGC, TT-669B/GGC, TT-699C/GGC.
TM 11-5820-251- 14P	Operator's Organizational, Direct Support, and General Support Maintenance Repair Parts and Special Tools List (Including Depot Maintenance Repair Parts and Special Tools): Masts AB-155/U (FSN 5820-251-2366), AB-155A/U (FSN 5985-507-6261), and AB-155B/U (FSN 5985-732-5146).
TM 11-5820-257-12P	Operator and Organizational Maintenance Repair Parts and Special Tool Lists and Maintenance Allocation Chart: Antenna Tuning Units BC-939-A and BC-939-B and Tuner, Radio Frequency TN-339/GR.
TM 11-5820-321-10P	Operator's Maintenance Repair Parts and Special Tools List: Modulators, Radio MD-239/GR and MD-239A/GR.
TM 11-5820-357-10	Operator's Manual: Radio Receiver R-390/URR.
TM 11-5820-358-10	Operator's Manual: Radio Receiver R-390A/URR.
TM 11-5820-359-12P	Operator and Organizational Maintenance Repair Parts and Special Tool Lists and Maintenance Allocation Chart: Power Supply PP-621/URR.
TM 11-5820479-12P	Operator and Organizational Maintenance Repair Parts and Special Tools List and Maintenance Allocation Chart: Mast Base MP-65, MP-65A and MP-65B.
TM 11-5930-201-14P	Operator's Organizational, Direct Support, and General Support Maintenance Repair Parts and Special Tools Lists (Including Depot Maintenance Repair Parts and Special Tools); Switch Box SA-331/U (FSN 5930-548-6806).
TM 11-5965-201-14P	Operator's, Organizational, Direct Support, and General Support Maintenance Repair Parts and Special Tools Lists (Including Depot Maintenance Repair Parts and Special Tools) Loudspeaker Assemblies LS-206/U and LS-206A/U (FSN 5965-347-0231).
TM 11-5965-224-14P	Operator's, Organizational, Direct Support and General Support Maintenance Repair Parts and Special Tools Lists (Including Depot Maintenance Repair Parts and Special Tools): Handsets H-60/PT (FSN 5965-669-9145) and H-165/U (FSN 5965-543-1837).
TM 11-5965-231-14P	Operator's, Organizational, Direct Support, and General Support Maintenance Repair Parts and Special Tools Lists (Including Depot Maintenance Repair Parts and Special Tools): Headset, Electrical H-113/U (FSN 5965-504-6370).
TM 11-6625-333-15	Operator's, Organizational, DS, GS, and Depot Maintenance Manual Including Repair Parts and Special Tools List; Standing-Wave-Ratio Power Meter ME-165/G.
TM 38-750	The Army Maintenance Management System (TAMMS).
TM 740-90-1	Administrative Storage of Equipment.
TM 750-244-2	Procedures for Destruction of Electronics Material to Prevent Enemy Use (Electronics Command).
SB 708-42	Federal Supply Code for Manufacturers; United States and Canada - Code to Name (Cataloging Handbook H4-2).

**APPENDIX B
BASIC ISSUE ITEMS LIST (BIIL) AND ITEMS TROOP
INSTALLED OR AUTHORIZED LIST (ITIAL)**

Section I. INTRODUCTION

B-1. Scope

This appendix lists only basic issue items required by the crew/operator for installation, operation, and maintenance of Radio Set AN/GRC-26D.

B-2. General

This Basic Issue Items and Items Troop Installed or Authorized List is divided into the following sections:

- a. Basic Issue Items List-Section II. A list, in alphabetical sequence, of items which are furnished with, and which must be turned in with the end item.
- b. Items Troop Installed or Authorized List Section III. See section III.

B-3. Explanation of Columns

The following provides an explanation of columns found in the tabular listings:

- a. *Illustration*. This column is divided as follows:
 - (1) *Figure Number*. Indicates the figure number of the illustration in which the item is shown.
 - (2) *Item Number*. Not applicable.
- b. *Federal Stock Number*. Indicates the Federal stock number assigned to the item and will be used for requisitioning purposes.
- c. *Part Number*. Indicates the primary number used by the manufacturer (individual, company, firm, corporation, or Government activity), which controls the design and characteristics of the item by means of its engineering drawings, specifications standards, and inspection requirements, to identify an item or range of items.

d. *Federal Supply Code for Manufacturer (FSCM)*.

The FSCM is a 5-digit numeric code used to identify the manufacturer, distributor, or Government agency, etc, and is identified in SB 08-42.

e. *Description*. Indicates the Federal item name and a minimum description required to identify the item.

f. *Unit of Measure (U/M)*. Indicates the standard of basic quantity of the listed item as used in performing the actual maintenance function. This measure is expressed by a two-character alphabetical abbreviation, (e.g., ea, in., pi, etc). When the unit of measure differs from the unit of issue, the lowest unit of issue that will satisfy the required units of measure will be requisitioned.

g. *Quantity Furnished with Equipment (Basic Issue Items Only)*. Indicates the quantity of the basic issue item furnished with the equipment.

h. *Quantity Authorized (Items Troop Installed or Authorized Only)*. Indicates the quantity of the item authorized to be used with the equipment.

B-4. Special Information

Usable on codes are included in Column 5. Uncoded items are applicable to all models. Identification of the usable on codes are as follows:

<i>Code</i>	<i>Used on</i>
1	AN/GRC-26D
2	AN/GRC-26D with MWO

Section II. BASIC ISSUE ITEMS LIST

(1) Illustration		(2) Federal stock number	(3) Part number	(4) FSCM	(5) Description Usable on code		(6) Unit of meas	(7) Qty furn with equip
(A) Fix No	(B) Item No							
B-4		5340-260-1314	MC 92		Padlock	1	EA	1
B-11		5975-511-8658	SC-B-75592A	80063	Rod Ground	1	EA	1
B-7	5	5815-348-2137			Cabinet Storage, CY-1721/GRC; CY-1721A/GRC	1	EA	1
B-7	4	2540-892-6243			Ladder, Vehicle, Boarding MX-3391/G	1	EA	1
B-1	1	6230-239-3518		81349	Light Extension: (25 Ft) 12293	1	EA	1
1-5		7110-082-6109			Cabinet, Filing, Security: HAF-358C		EA	1
B-9	2	5820-497-8792	SC-B-27964	80063	Strap, Webbing	1	EA	1
B-14		5820-576-5379	SC-C-19825	80063	Strap, Webbing	1	EA	1
B-7	3	5815-813-9768	SC-C-19825A	80063	Strap, Webbing	1	EA	1
B-14	4	5815-579-6007	SC-D-19825B	80063	Strap, Mounting	1	EA	4
1-4		6645-303-4950		36922	Clock, Aircraft, Mechanical: All	1	EA	1
B-3	3	7920-663-3240			Broom, Upright	1	EA	1
B-13	2	7110-273-3962		24052	Chair, Rotary: 2123	1	EA	2
B-13		7105-514-5090			Chair, Folding	1	EA	1
B-10	1	7520-254-4610			Clip Board, File	1	EA	1

Section III. ITEMS TROOP INSTALLED OR AUTHORIZED LIST

(1) SMR CODE	(2) Federal stock number	(3) Description Reference Number & Mfr. Code	Usable on code	(4) Unit of meas.	(5) Qty auth.
	5120-223-7013	Wrench, socket; SC-C-28016;80063	1	EA	1

Change 1 B-2

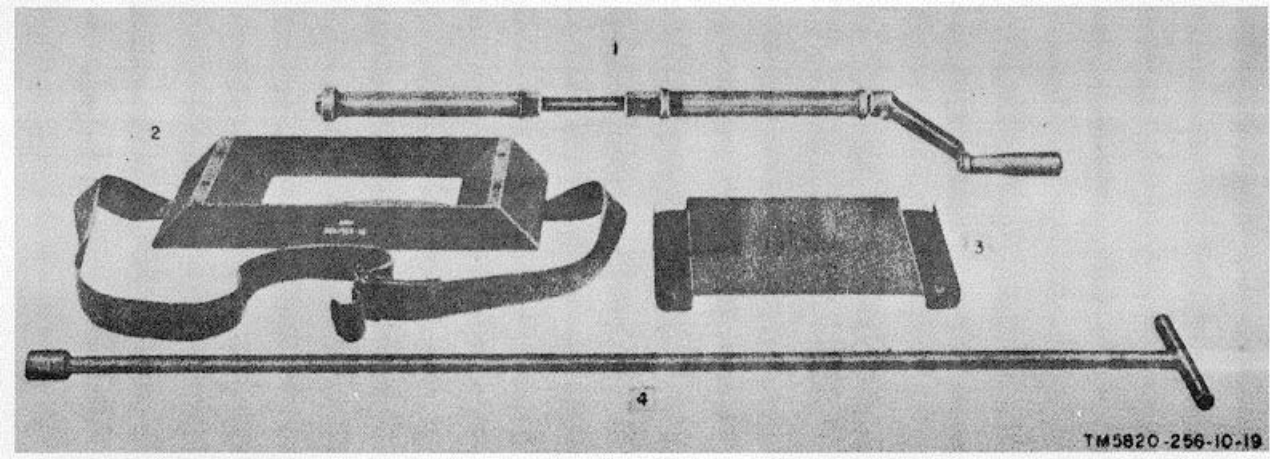
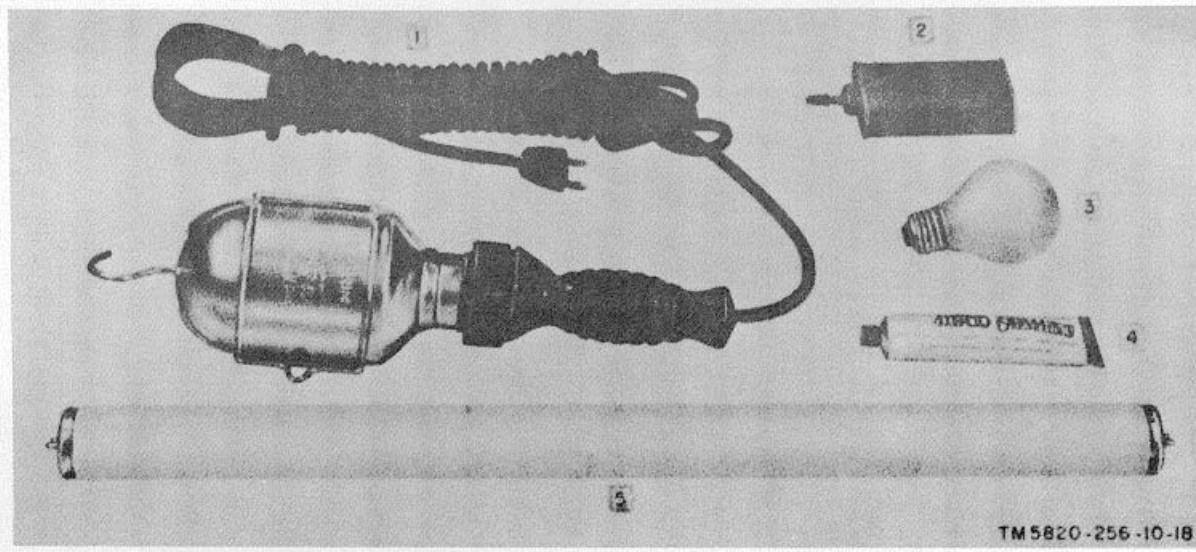

(Next printed page is B-7)

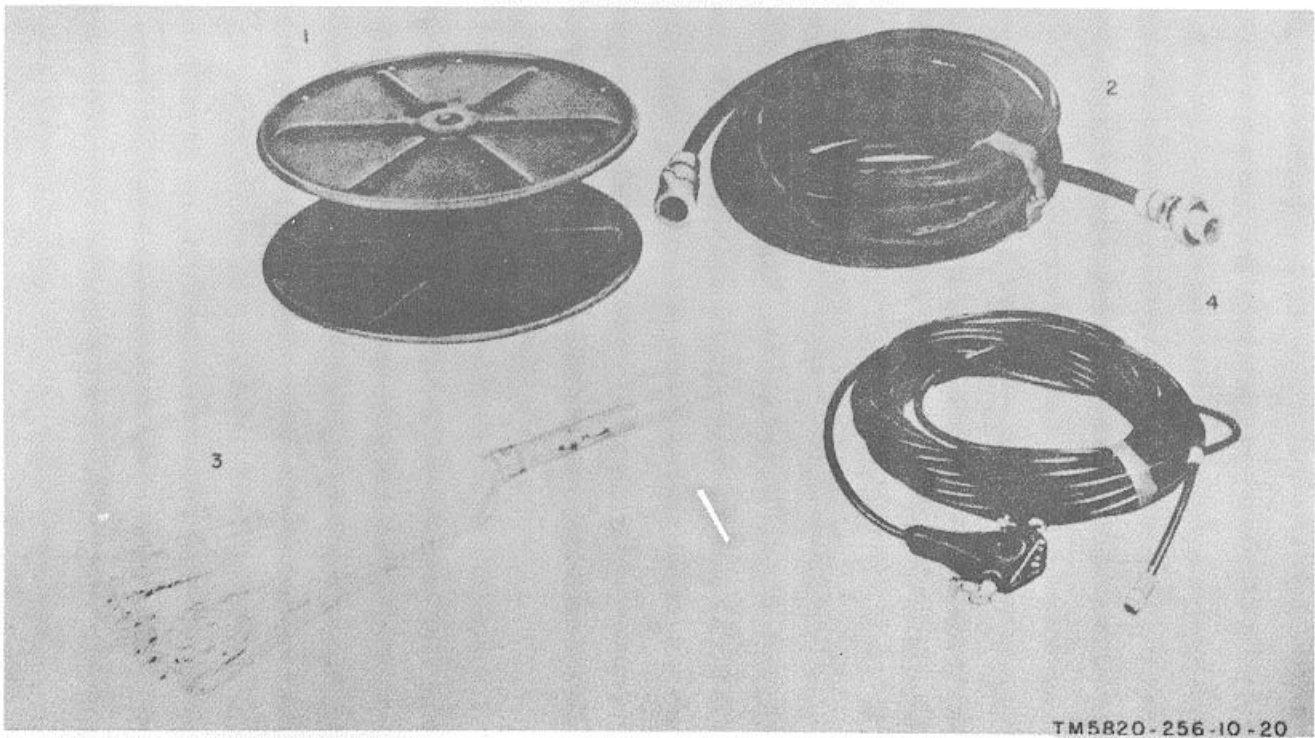

TM5820-256-10-20

Figure B-3.

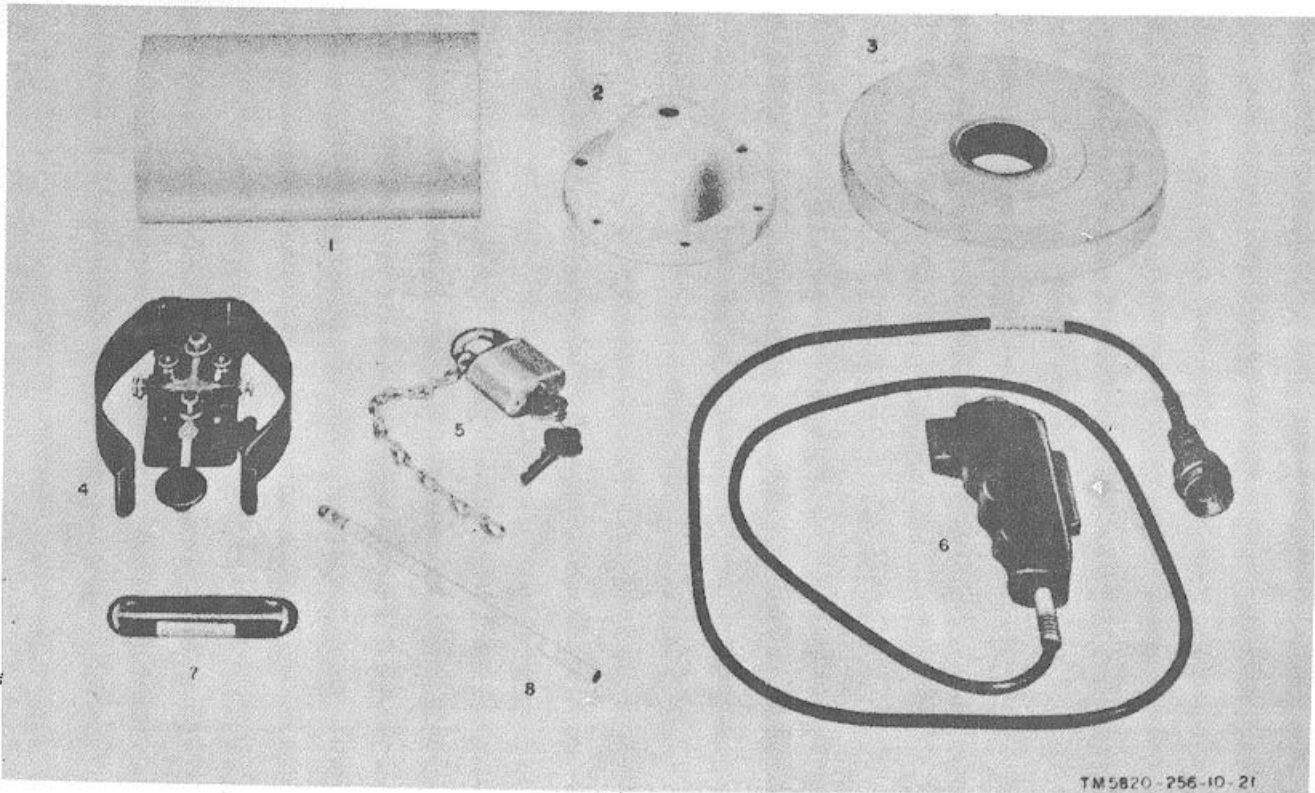

TM5820-256-10-21

Figure B-4.

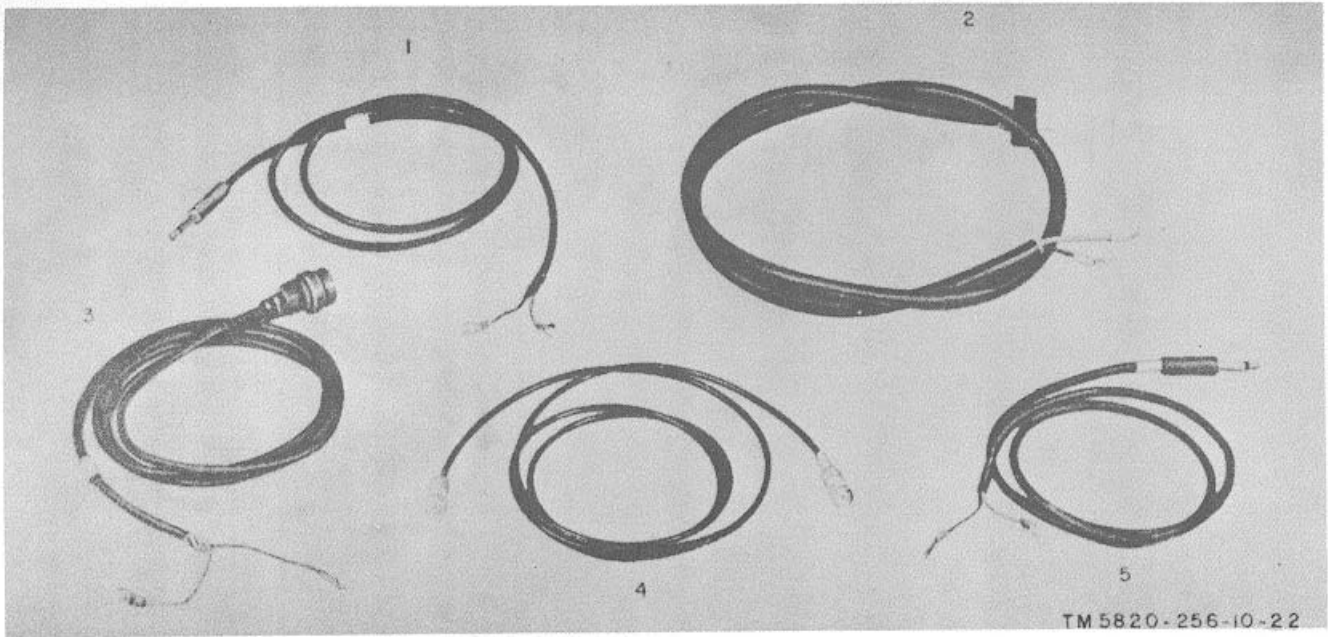

Figure B-5.

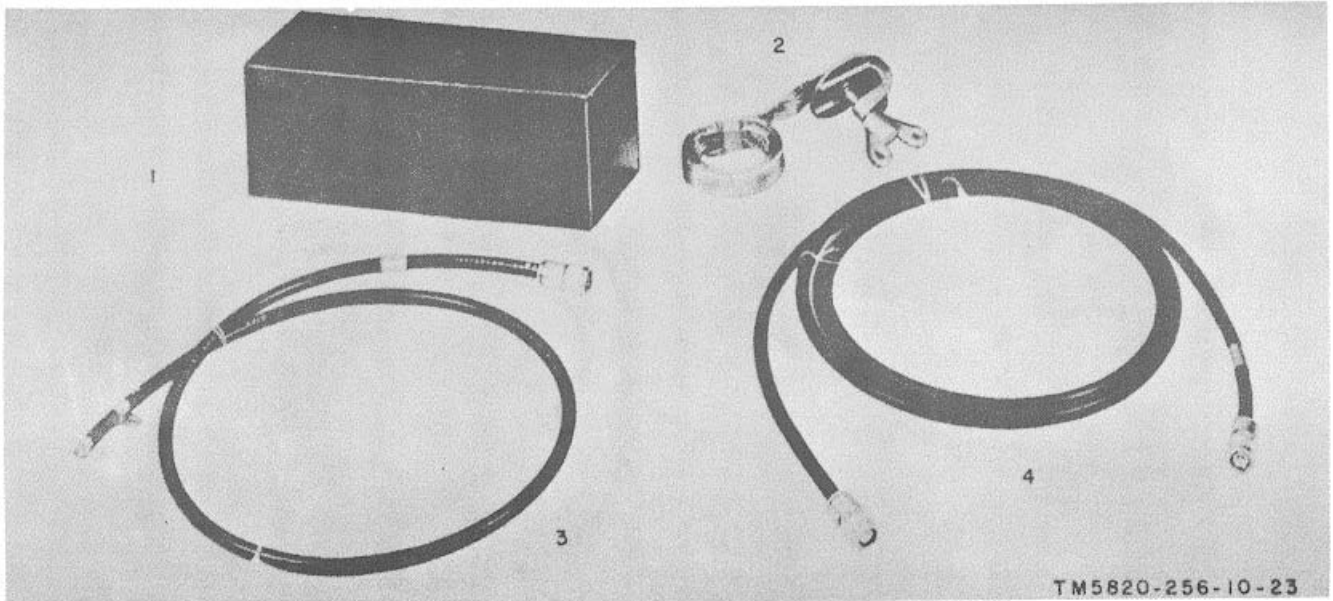
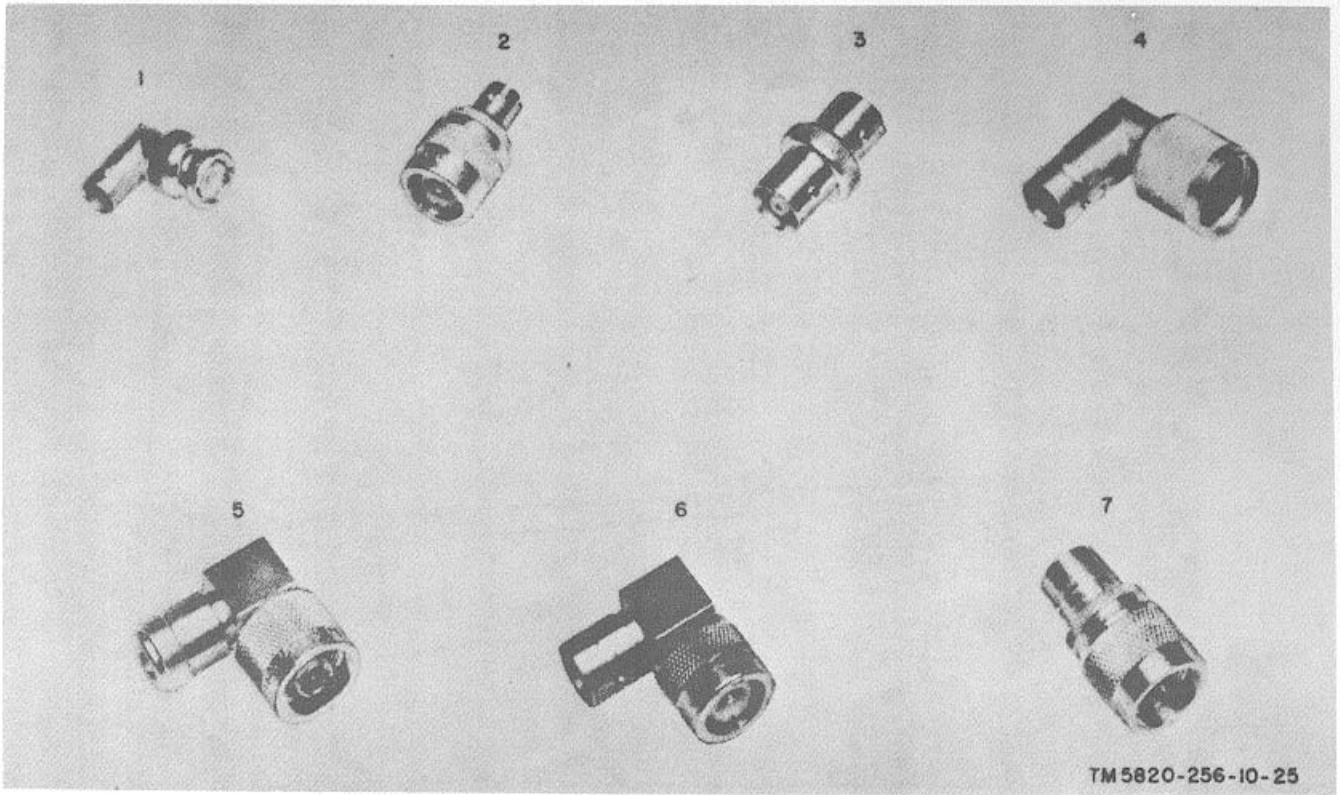

Figure B-6.

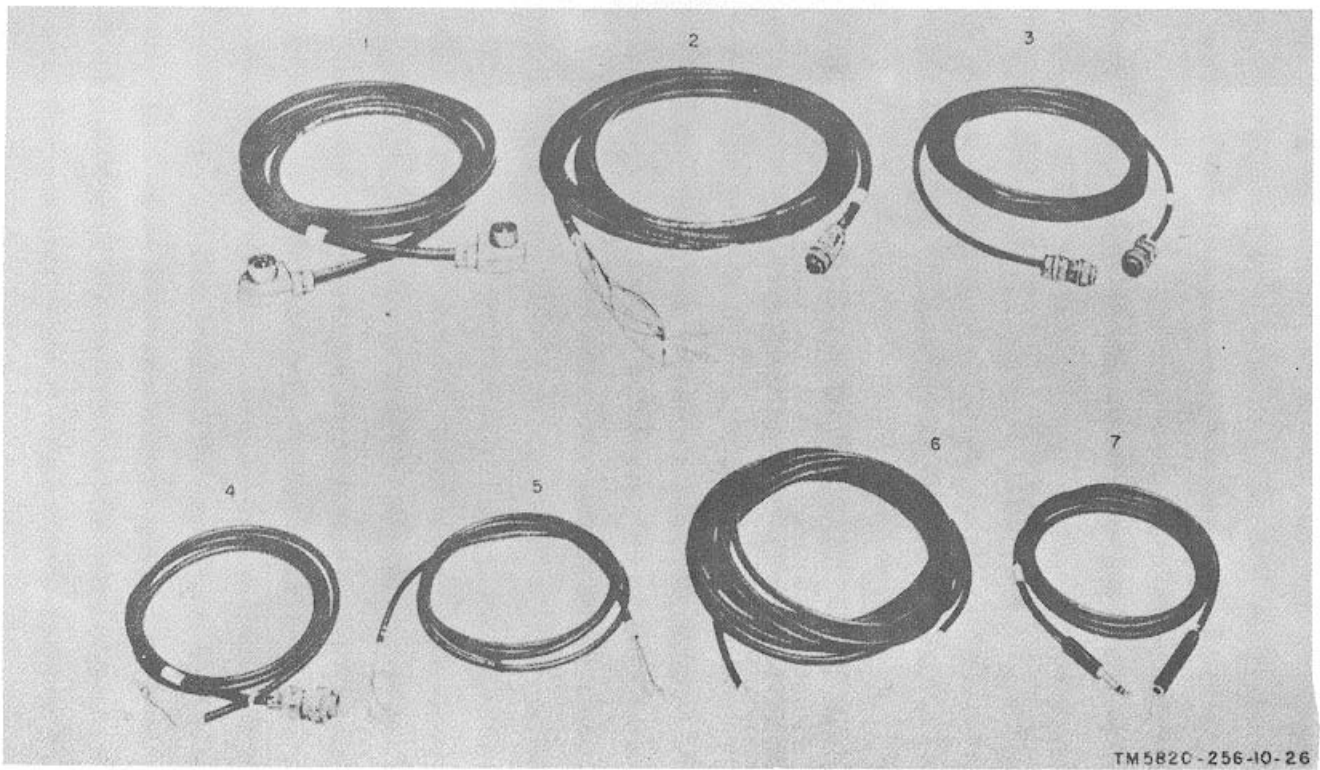

Figure B-7.



TM 5820-256-10-25

Figure B-8.



TM 5820-256-10-26

Figure B-9.

B-11

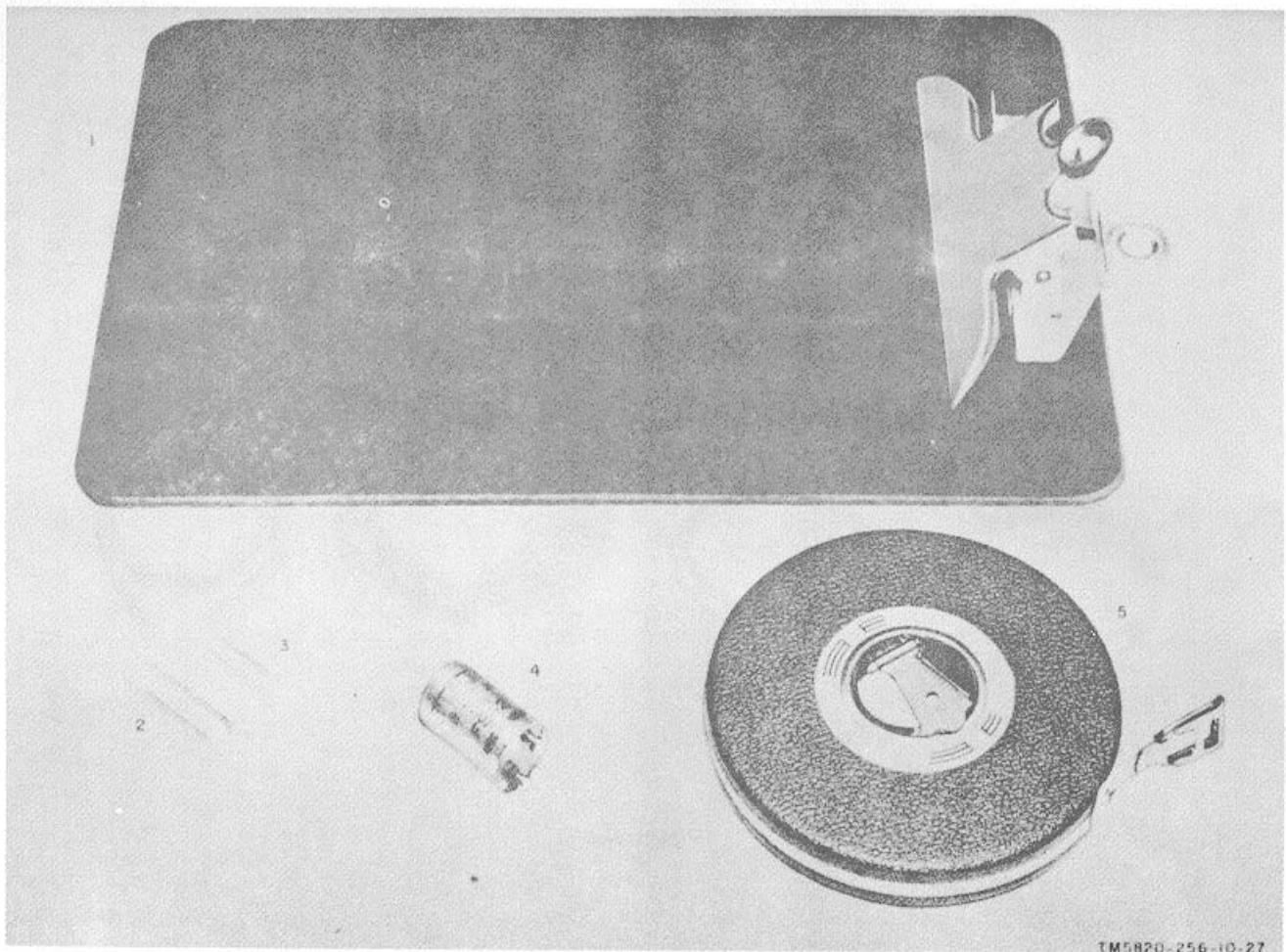

TM5820-256-10-27

Figure B-10.

B-12

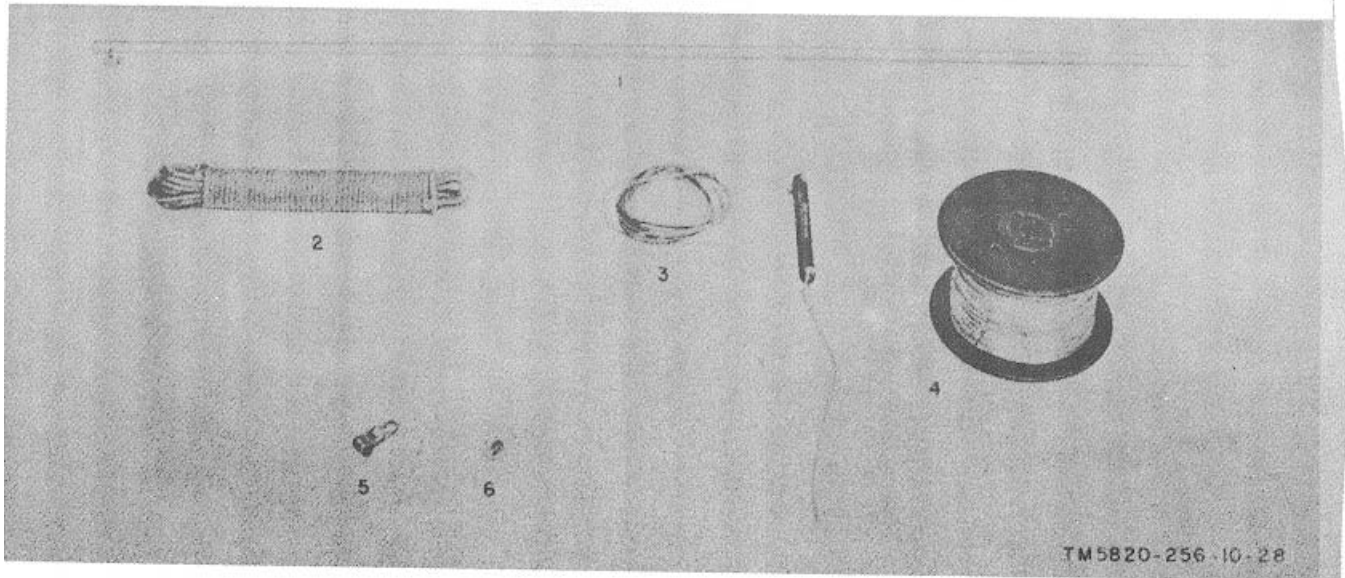

Figure B-11.

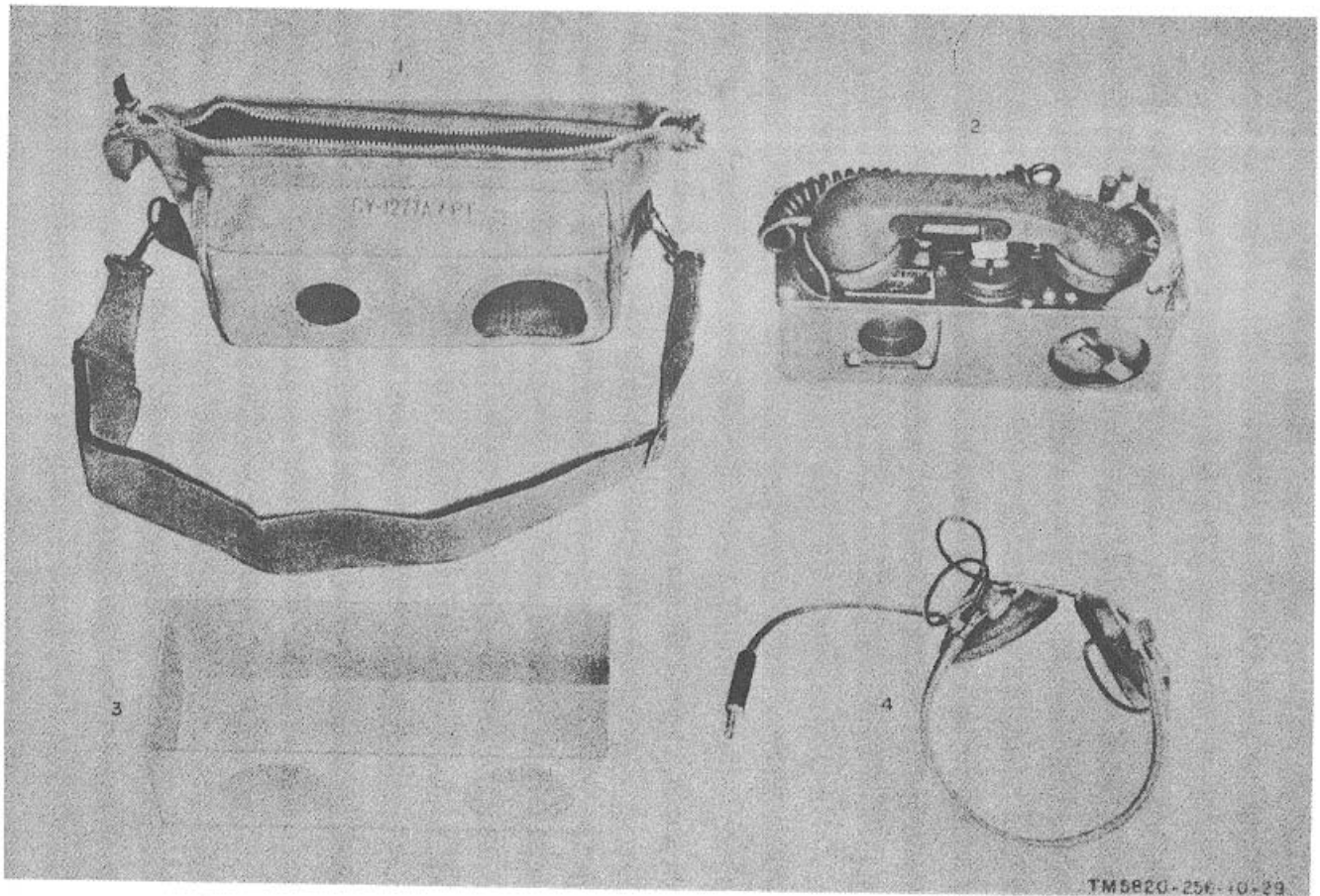

Figure B-12.

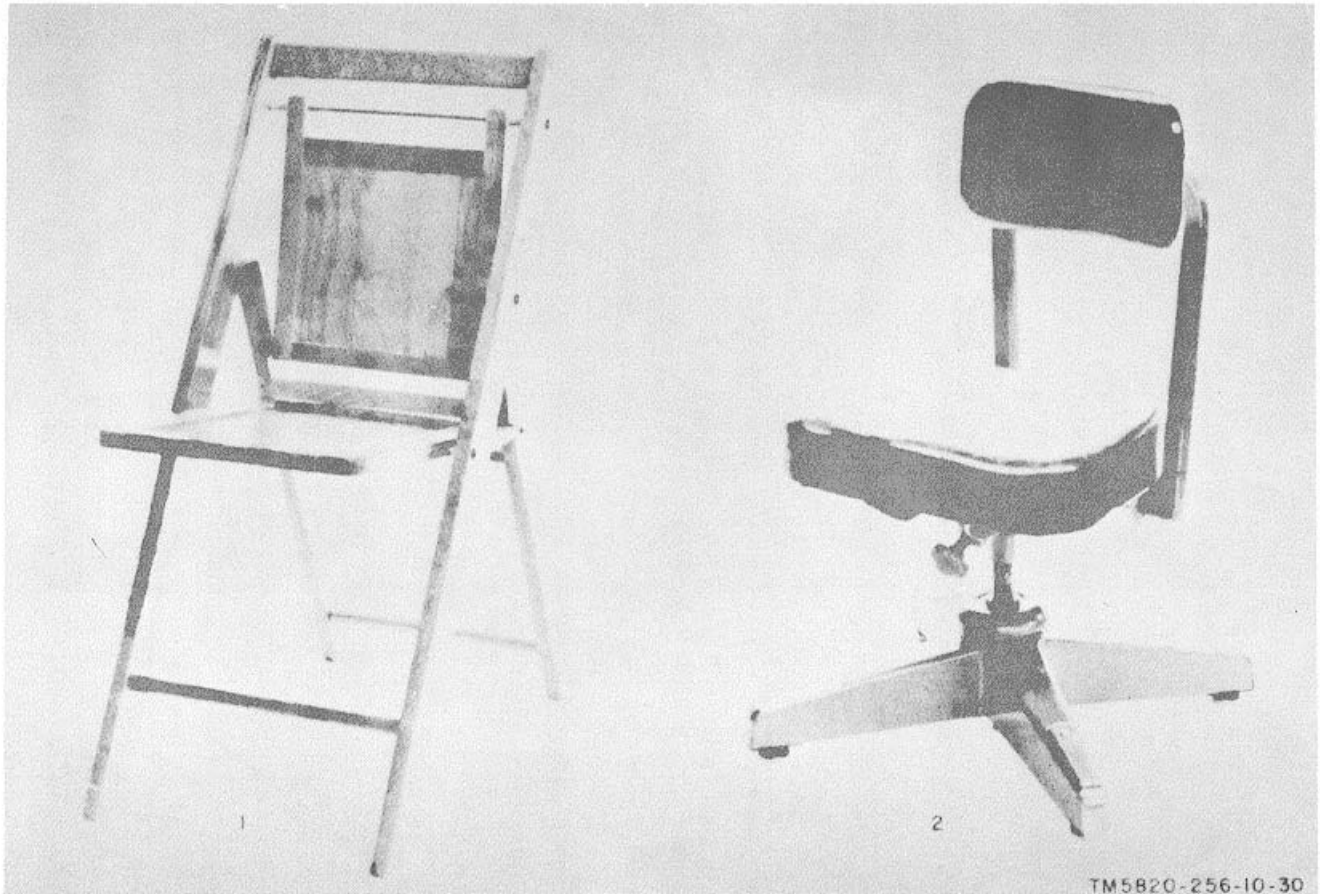

Figure B-13.

B-14

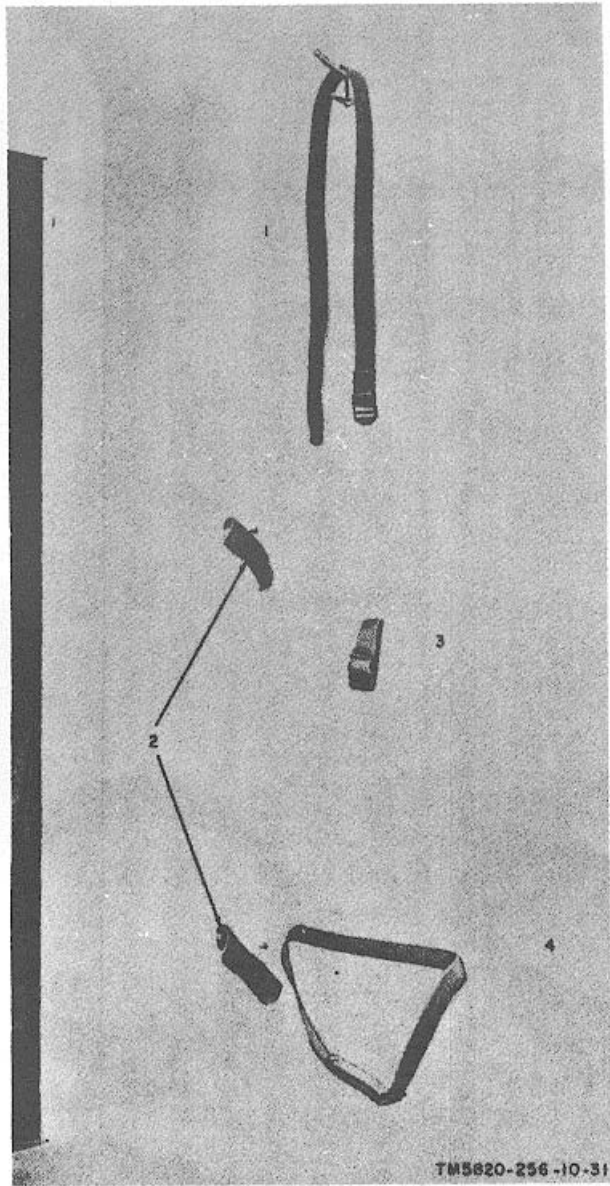

Figure B-14.

B-15

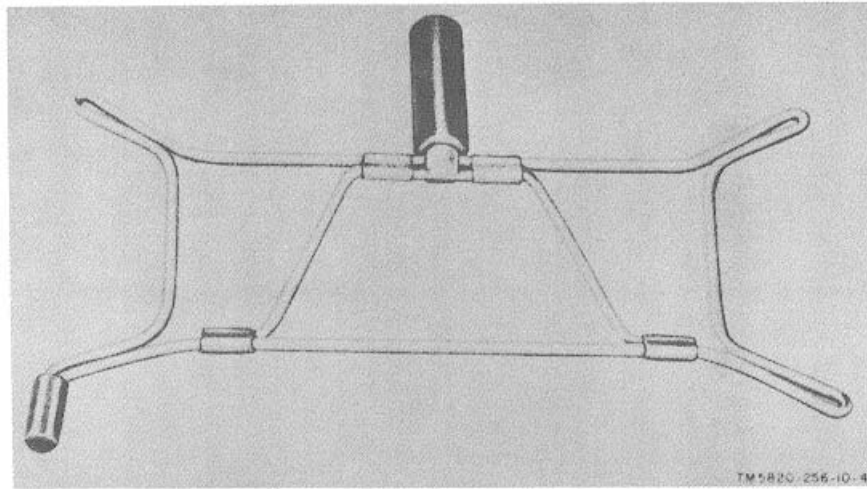

Figure B-15.

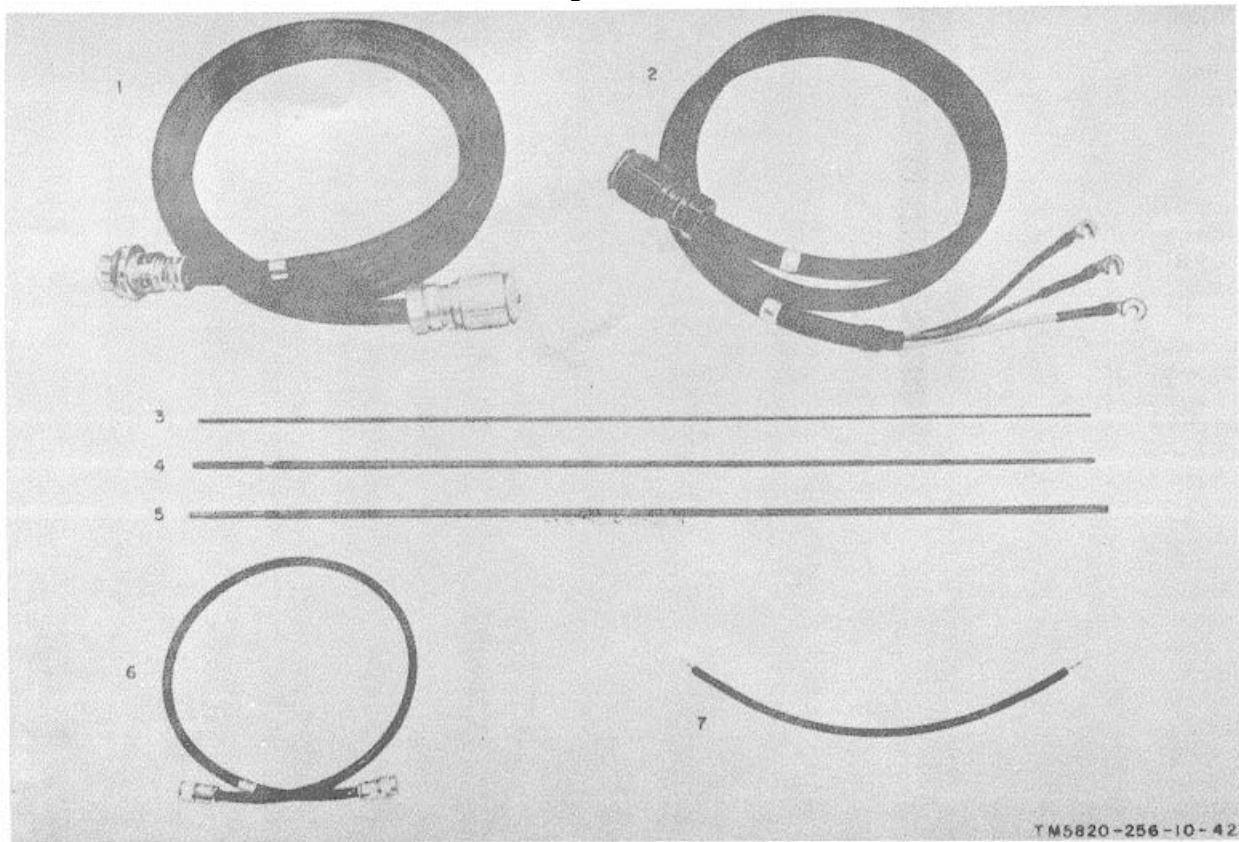

Figure B-16.

B-16

INDEX

	Paragraph	Page
Accessories, operating	1-28	1-7
Adjustments, initial	2-10	2-9
Am. voice operation	3-11	3-11
Antennas:		
Doublet and Mast AB-156(*)/U	2-6, 1-26	2-3, 1-6
Whip	2-5	2-2
Antijamming	3-15	3-13
Assembly, Loudspeaker LS-206(*)/U	1-15	1-5
Authority, demolition	5-3	5-1
Blower Assembly, Electrical HD-223/G:		
Controls	3-4	3-3
Description	1-9	1-4
C-1123/GRC	1-10, 3-2	1-4, 3-1
C-1474/GRC	1-21	1-6
Cabinet, Electrical Equipment CY-1807/G description	1-29	1-7
Cabinet, Storage CY1721(*)/GRC description	1-29	1-7
Checking unpacked equipment	2-3	2-2
Cleaning	4-7	4-2
Clock, description	1-29	1-7
Components, nonoperating	1-29	1-7
Connections	2-9	2-8
Control, Radio Set C-1123/GRC	1-10	1-4
Control, Remote Switching C-1474/GRC	1-21, 3-4	1-6, 3-3
Controls, indicators, and jacks:		
C-1123/GRC	3-3	3-1
MD-239(*)/GR	3-2	3-1
Minor components	3-4	3-3
Converter, Frequency Shift CV-416(*)/URR	1-11	1-4
CV-116(*)/URR	1-11	1-4
Cw operation	3-13	3-12
Daily preventive maintenance checks and services chart	4-5	4-2
Destruction, methods	5-4	5-1
Differences, models	1-28	1-7
Disassembly, equipment	5-1	5-1
Doublet antennas	2-6, 1-26	2-3, 1-6
Forms and records	1-3	1-1
Frequency Shift Converter CV-116(*)/URR	1-11	1-4
Fsk-am. operation	3-12	3-11
Fsk operation	3-10	3-10
Fuses and batteries, installation	2-7	2-7
Generator Set, Gasoline Engine, Trailer Mounted PU-474/M	1-27	1-7
Generator Set, Gasoline Engine, Trailer Mounted PU-294/G	1-26	1-6
Heater	1-24	1-6
Indexes, publications	1-2	1-1
Indicators, controls, and jacks:		
C-1123/GRC	3-3	3-1
MD-239 (*)/GR	3-2	3-1
Initial adjustments	2-10	2-9
Installation:		
Doublet antennas and Mast AB-155(*)/U	2-6	2-3
Fuses and batteries	2-7	2-7
Operator's chairs	2-8	2-8
Shelter, Electrical Equipment S-56(*)/G	2-4	2-2
Whip antenna	2-5	2-2
Interconnection Box J-224/GRC	1-23	1-6

	Paragraph	Page
Interconnection Box J-2623/GRC.....	1-22	1-6
Junction Box J-2598/GRC.....	1-25	1-6
Junction Box J-2597/GRC.....	1-24	1-6
Key, Telegraph KY-116/U.....	1-28	1-7
Lubrication instructions.....	4-8	4-3
Loudspeaker Assembly LS-206(*)/U.....	1-15	1-5
Maintenance:		
Checks.....	4-9	4-8
Checks and services periods.....	4-4	4-1
Preventive, checks and services charts.....	4-5, 4-6	4-2
Mast AB-155(*)/U.....	2-6	2-3
ME-165/G.....	1-18	1-6
MD-239(*)/GR.....	1-16	1-5
Models, differences.....	1-28	1-7
Modulator, Radio MD39(*)/GR.....	1-16	1-5
Nomenclature and common names.....	1-6	1-3
Nonoperating components.....	1-29	1-7
Operating:		
Accessories.....	1-28	1-7
Conditions.....	3-9	3-10
Operation:		
Am. voice.....	3-11	3-11
Cw.....	3-13	3-12
Fsk.....	3-10	3-10
Fsk-am.....	3-14	3-12
Types.....	3-5	3-7
Operator's controls and indicators:.....	3-1	3-1
C-1123/GRC.....	3-3	3-1
MD-239(*)/GR.....	3-2	3-1
Minor components.....	3-4	3-3
Preliminary starting procedure.....	3-6	3-7
Preventive maintenance:.....	4-3	4-1
Checks and services:		
Charts.....	4-5,4-6	4-2
Periods.....	4-4	4-1
Procedures:		
Preliminary starting.....	3-6	3-7
Starting.....	3-7	3-8
Stopping.....	3-16	3-13
Tuning.....	3-8	3-8
PU474/M.....	1-25	1-6
PU-294/G.....	1-24	1-6
Purpose and use.....	1-4	1-2
R-S90(*)/URR.....	1-12	1-5
Radio Set AN/GRC-26D.....	1-7	1-3
Radio Transmitter T368(*)/URT.....	1-17	1-6
Receiver, Radio R4390(*)/URR.....	1-12	1-5
Recognition and identification, jamming.....	3-14	3-12
Repackaging, shipment or limited storage.....	5-2	5-1
Reperforator-Transmitter, Teletypewriter TT-76(*)/GGC.....	1-13	1-5
Scope:		
Manual.....	1-1	1-1
Operator's maintenance.....	4-1	4-4
Shelter, Electrical Equipment S-56(*)/G.....	1-8	1-3
Siting.....	2-1	2-1
Standing Wave Ratio-Power Meter ME-165/G.....	1-18	1-6
Starting procedure.....	3-7	3-8
Stopping procedure.....	3-16	3-13
Switch Box SA-331/U.....	1-28	1-7
Technical characteristics.....	1-5	1-2
Telephone Set TA-312/PT.....	1-20	1-6
Teletypewriter TT-98(*)/FG.....	1-14	1-5
TN-339/GR.....	1-19	1-6

	Paragraph	Page
Tools required, maintenance	4-2	4-1
Transmitter, Radio T-668(*)/URT	1-17	1-6
TT-98(*)/FG	1-14	1-5
TT-76(*)/GGC	1-13	1-5
Tuner, Radio Frequency TN-389/GR	1-19	1-6
Tuning procedure	3-8	3-8
Unpacking	2-2	2-1
Weekly preventive maintenance checks and services chart	4-6	4-2
Whip antenna:		
Description	1-28	1-7
Installation	2-5	2-2

By Order of the Secretary of the Army:

W.C. WESTMORELAND,
General, United States Army,
Chief of Staff.

Official:

KENNETH O., WICKHAM
Major General, United States Army,
The Adjutant General.

Distribution:

To be distributed in accordance with DA Form 12-51, (qty rqr block no. 97) Operator maintenance requirements for AN/GRC-26 Radio Set.

THE METRIC SYSTEM AND EQUIVALENTS

LINEAR MEASURE

- 1 Centimeter = 10 Millimeters = 0.01 Meters = 0.3937 Inches
- 1 Meter = 100 Centimeters = 1,000 Millimeters = 39.37 Inches
- 1 Kilometer = 1,000 Meters = 0.621 Miles

SQUARE MEASURE

- 1 Sq Centimeter = 100 Sq Millimeters = 0.155 Sq Inches
- 1 Sq Meter = 10,000 Sq Centimeters = 10.76 Sq Feet
- 1 Sq Kilometer = 1,000,000 Sq Meters = 0.386 Sq Miles

CUBIC MEASURE

- 1 Cu Centimeter = 1,000 Cu Millimeters = 0.06 Cu Inches
- 1 Cu Meter = 1,000,000 Cu Centimeters = 35.31 Cu Feet

LIQUID MEASURE

- 1 Milliliter = 0.001 Liters = 0.0338 Fluid Ounces
- 1 Liter = 1,000 Milliliters = 33.82 Fluid Ounces

TEMPERATURE

- $5/9 (^{\circ}\text{F} - 32) = ^{\circ}\text{C}$
- 212° Fahrenheit is equivalent to 100° Celsius
- 90° Fahrenheit is equivalent to 32.2° Celsius
- 32° Fahrenheit is equivalent to 0° Celsius
- $9/5 \text{ } ^{\circ}\text{C} + 32 = \text{ } ^{\circ}\text{F}$

WEIGHTS

- 1 Gram = 0.001 Kilograms = 1,000 Milligrams = 0.035 Ounces
- 1 Kilogram = 1,000 Grams = 2.2 lb.
- 1 Metric Ton = 1,000 Kilograms = 1 Megagram = 1.1 Short Tons

APPROXIMATE CONVERSION FACTORS

TO CHANGE	TO	MULTIPLY BY
Inches	Centimeters	2.540
Feet	Meters	0.305
Yards	Meters	0.914
Miles	Kilometers	1.609
Square Inches	Square Centimeters	6.451
Square Feet	Square Meters	0.093
Square Yards	Square Meters	0.836
Square Miles	Square Kilometers	2.590
Acres	Square Hectometers	0.405
Cubic Feet	Cubic Meters	0.028
Cubic Yards	Cubic Meters	0.765
Fluid Ounces	Milliliters	29.573
Pints	Liters	0.473
Quarts	Liters	0.946
Gallons	Liters	3.785
Ounces	Grams	28.349
Pounds	Kilograms	0.454
Short Tons	Metric Tons	0.907
Pound-Feet	Newton-Meters	1.356
Pounds Per Square Inch	Kilopascals	6.895
Miles Per Gallon	Kilometers Per Liter	0.425
Miles Per Hour	Kilometers Per Hour	1.609
TO CHANGE	TO	MULTIPLY BY
Centimeters	Inches	0.394
Meters	Feet	3.280
Meters	Yards	1.094
Kilometers	Miles	0.621
Square Centimeters	Square Inches	0.155
Square Meters	Square Feet	10.764
Square Meters	Square Yards	1.196
Square Kilometers	Square Miles	0.386
Square Hectometers	Acres	2.471
Cubic Meters	Cubic Feet	35.315
Cubic Meters	Cubic Yards	1.308
Milliliters	Fluid Ounces	0.034
Liters	Pints	2.113
Liters	Quarts	1.057
Liters	Gallons	0.264
Grams	Ounces	0.035
Kilograms	Pounds	2.205
Metric Tons	Short Tons	1.102
Newton-Meters	Pound-Feet	0.738
Kilopascals	Pounds Per Square Inch	0.145
Kilometers Per Liter	Miles Per Gallon	2.354
Kilometers Per Hour	Miles Per Hour	0.621

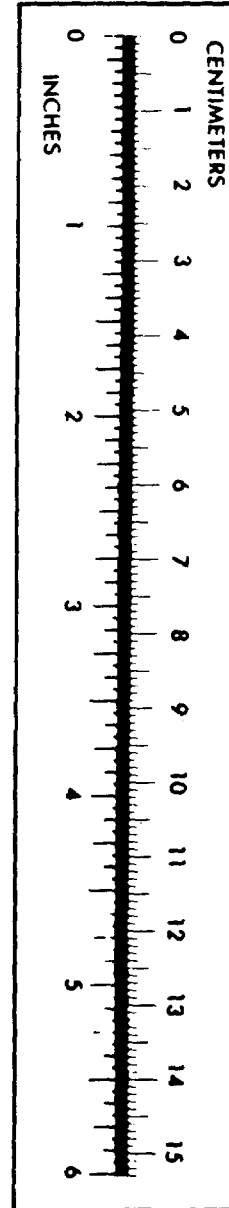

RECOMMENDED CHANGES TO EQUIPMENT TECHNICAL PUBLICATIONS



THEN... JOT DOWN THE DOPE ABOUT IT ON THIS FORM, CAREFULLY TEAR IT OUT, FOLD IT AND DROP IT IN THE MAIL!

SOMETHING WRONG WITH THIS PUBLICATION?

FROM: (PRINT YOUR UNIT'S COMPLETE ADDRESS)

DATE SENT

PUBLICATION NUMBER

PUBLICATION DATE

PUBLICATION TITLE

BE EXACT... PIN-POINT WHERE IT IS

PAGE NO.

PARA-GRAPH

FIGURE NO.

TABLE NO.

IN THIS SPACE TELL WHAT IS WRONG AND WHAT SHOULD BE DONE ABOUT IT:

TEAR ALONG PERFORATED LINE

PRINTED NAME, GRADE OR TITLE, AND TELEPHONE NUMBER

SIGN HERE:

DA FORM 2028-2 JUL 79

PREVIOUS EDITIONS ARE OBSOLETE.

P.S.—IF YOUR OUTFIT WANTS TO KNOW ABOUT YOUR RECOMMENDATION MAKE A CARBON COPY OF THIS AND GIVE IT TO YOUR HEADQUARTERS.

PIN: 010149-000